

# TeSys GV5 / GV6

## Motor Circuit Breakers and Manual Motor Protectors

### User Guide

03/2020



---

The information provided in this documentation contains general descriptions and/or technical characteristics of the performance of the products contained herein. This documentation is not intended as a substitute for and is not to be used for determining suitability or reliability of these products for specific user applications. It is the duty of any such user or integrator to perform the appropriate and complete risk analysis, evaluation and testing of the products with respect to the relevant specific application or use thereof. Neither Schneider Electric nor any of its affiliates or subsidiaries shall be responsible or liable for misuse of the information contained herein. If you have any suggestions for improvements or amendments or have found errors in this publication, please notify us.

You agree not to reproduce, other than for your own personal, noncommercial use, all or part of this document on any medium whatsoever without permission of Schneider Electric, given in writing. You also agree not to establish any hypertext links to this document or its content. Schneider Electric does not grant any right or license for the personal and noncommercial use of the document or its content, except for a non-exclusive license to consult it on an "as is" basis, at your own risk. All other rights are reserved.

All pertinent state, regional, and local safety regulations must be observed when installing and using this product. For reasons of safety and to help ensure compliance with documented system data, only the manufacturer should perform repairs to components.

When devices are used for applications with technical safety requirements, the relevant instructions must be followed.

Failure to use Schneider Electric software or approved software with our hardware products may result in injury, harm, or improper operating results.

Failure to observe this information can result in injury or equipment damage.

© 2020 Schneider Electric. All rights reserved.

---

# Table of Contents

---



	<b>Safety Information</b> .....	<b>5</b>
	<b>About the Book</b> .....	<b>7</b>
<b>Chapter 1</b>	<b>Introduction</b> .....	<b>9</b>
	TeSys GV5 / GV6 Devices .....	<b>10</b>
	Device Overview .....	<b>11</b>
	Environmental Conditions .....	<b>16</b>
<b>Chapter 2</b>	<b>Operating the Device</b> .....	<b>19</b>
	Opening, Closing, and Resetting the Device .....	<b>20</b>
	Testing a Device With Direct Rotary Handle .....	<b>22</b>
	Locking a Device With Direct Rotary Handle .....	<b>23</b>
	Testing a Device With Extended Rotary Handle .....	<b>25</b>
	Locking a Device With Extended Rotary Handle .....	<b>27</b>
	De-Energizing the Device .....	<b>29</b>
<b>Chapter 3</b>	<b>Protection Functions</b> .....	<b>31</b>
	Protection for Motor-Feeders .....	<b>32</b>
	Motor Operating States .....	<b>34</b>
	Trip Unit Description .....	<b>35</b>
	Overload or Thermal Protection (ANSI 49) .....	<b>37</b>
	Short-Time Protection (ANSI 51) .....	<b>40</b>
	Instantaneous Protection (ANSI 50) .....	<b>41</b>
	Phase Unbalance Protection (ANSI 46) .....	<b>42</b>
<b>Chapter 4</b>	<b>Electrical Auxiliary Devices</b> .....	<b>45</b>
	Electrical Auxiliary Devices .....	<b>46</b>
	Indication Contacts .....	<b>49</b>
	Voltage Trip Releases .....	<b>51</b>
	SDTAM Thermal Fault Module .....	<b>52</b>
<b>Appendices</b>	.....	<b>55</b>
<b>Appendix A</b>	<b>Additional Characteristics</b> .....	<b>57</b>
	Motor-Feeder Protection .....	<b>58</b>
	Reflex Tripping .....	<b>61</b>
	Limitation Curves .....	<b>62</b>
<b>Glossary</b>	.....	<b>65</b>

---



## Important Information

### NOTICE

Read these instructions carefully, and look at the equipment to become familiar with the device before trying to install, operate, service, or maintain it. The following special messages may appear throughout this documentation or on the equipment to warn of potential hazards or to call attention to information that clarifies or simplifies a procedure.



The addition of this symbol to a “Danger” or “Warning” safety label indicates that an electrical hazard exists which will result in personal injury if the instructions are not followed.



This is the safety alert symbol. It is used to alert you to potential personal injury hazards. Obey all safety messages that follow this symbol to avoid possible injury or death.

### **DANGER**

**DANGER** indicates a hazardous situation which, if not avoided, **will result in** death or serious injury.

### **WARNING**

**WARNING** indicates a hazardous situation which, if not avoided, **could result in** death or serious injury.

### **CAUTION**

**CAUTION** indicates a hazardous situation which, if not avoided, **could result in** minor or moderate injury.

### **NOTICE**

**NOTICE** is used to address practices not related to physical injury.

### PLEASE NOTE

Electrical equipment should be installed, operated, serviced, and maintained only by qualified personnel. No responsibility is assumed by Schneider Electric for any consequences arising out of the use of this material.

A qualified person is one who has skills and knowledge related to the construction and operation of electrical equipment and its installation, and has received safety training to recognize and avoid the hazards involved.

---

# About the Book



## At a Glance

### Document Scope

This guide provides users, installers, and maintenance personnel with technical information needed to operate TeSys™ GV5 and TeSys™ GV6 devices in compliance with the IEC/EN and UL/CSA standards:

- In IEC/EN standards, TeSys GV5 / GV6 devices are motor circuit breakers.
- In UL/CSA standards, TeSys GV5 / GV6 devices are manual motor protectors.

In this guide, the term *device* covers:

- Motor circuit breakers
- Manual motor protectors

### Validity Note

This document applies to TeSys GV5 devices and TeSys GV6 devices.

### Online Information

The information contained in this guide is likely to be updated at any time. Schneider Electric strongly recommends that you have the most recent and up-to-date version available on [www.schneider-electric.com/tesys](http://www.schneider-electric.com/tesys).

The technical characteristics of the devices described in the present document also appear online. To access the information online:

Step	Action
1	Go to the Schneider Electric home page <a href="http://www.schneider-electric.com">www.schneider-electric.com</a> .
2	In the <b>Search</b> box type the reference of a product or the name of a product range. <ul style="list-style-type: none"><li>• Do not include blank spaces in the reference or product range.</li><li>• To get information on grouping similar modules, use asterisks (*).</li></ul>
3	If you entered a reference, go to the <b>Product Datasheets</b> search results and click on the reference that interests you. If you entered the name of a product range, go to the <b>Product Ranges</b> search results and click on the product range that interests you.
4	If more than one reference appears in the <b>Products</b> search results, click on the reference that interests you.
5	Depending on the size of your screen, you may need to scroll down to see the datasheet.
6	To save or print a datasheet as a .pdf file, click <b>Download XXX product datasheet</b> .

The characteristics that are described in the present document should be the same as those characteristics that appear online. In line with our policy of constant improvement, we may revise content over time to improve clarity and accuracy. If you see a difference between the document and online information, use the online information as your reference.

### Related Documents

Title of documentation	Reference number
<i>TeSys Motor Control and Protection Components Catalog</i>	<a href="#">MKTED210011EN</a>
<i>TeSys GV5P - Motor Circuit Breaker (IEC) and Manual Motor Protector (UL/CSA) - Instruction Sheet</i>	<a href="#">MFR49208</a>
<i>TeSys GV6P - Motor Circuit Breaker (IEC) and Manual Motor Protector (UL/CSA) - Instruction Sheet</i>	<a href="#">MFR49209</a>

You can download these technical publications and other technical information from our website at [www.schneider-electric.com](http://www.schneider-electric.com)

### Trademark Notice

All trademarks are owned by Schneider Electric Industries SAS or its affiliated companies.





---

# Chapter 1

## Introduction

---

### What Is in This Chapter?

This chapter contains the following topics:

Topic	Page
TeSys GV5 / GV6 Devices	10
Device Overview	11
Environmental Conditions	16

## TeSys GV5 / GV6 Devices

### Description

TeSys GV5 / GV6 devices offer current ratings from 150 to 500 A, for AC power systems up to 690 Vac.

TeSys GV5 / GV6 devices are available in the following frame sizes:

- TeSys GV5 for current ratings from 150 to 220 A
- TeSys GV6 for current ratings from 320 to 500 A

TeSys GV5 / GV6 devices have the following features:

- Direct rotary handle
- 3-pole devices
- 5, 10 and 20 trip classes
- The following accessories are optional and installable on site:
  - Voltage trip releases
  - Auxiliary contacts
  - Insulation accessories

### Device Identification

The commercial reference of each device provides information about:

- The size of the device
- The type of protection the device provides
- The current rating of the device
- The breaking capacity of the device

For example, the commercial reference of the GV5P 220H device contains the following information:

- GV5: The device is a TeSys GV5 device.
- P: The device offers protection against overloads and short-circuits.
- 220: The device has a current rating of 220 A.
- H: The breaking capacity of the device is 70 kA at 415 Vac.

### Breaking Capacity

The following table shows the breaking capacity ( $I_{cs} = I_{cu}$ ) in kA rms for TeSys GV5 / GV6 devices:

AC power systems	TeSys GV5PGV5 P 150F	TeSys GV5PGV5 P 150H	TeSys GV5PGV5 P 220F	TeSys GV5PGV5 P 220H	TeSys GV6PGV6 P 320F	TeSys GV6PGV6 P 320H	TeSys GV6PGV6 P 500F	TeSys GV6PGV6 P 500H
230 Vac	85 kA	100 kA	85 kA	100 kA	40 kA	100 kA	40 kA	100 kA
400/415 Vac	36 kA	70 kA	36 kA	70 kA	36 kA	70 kA	36 kA	70 kA
440 Vac	35 kA	65 kA	35 kA	65 kA	30 kA	65 kA	30 kA	65 kA
500 Vac	30 kA	50 kA	30 kA	50 kA	25 kA	50 kA	25 kA	50 kA
660/690 Vac	8 kA	10 kA	8 kA	10 kA	10 kA	10 kA	10 kA	10 kA

### Standard Compliance

TeSys GV5 / GV6 devices are compliant with the following standards:

- IEC/EN 60947-2 and IEC/EN 60947-4-1 for motor protection circuit breakers
- UL 60947-4-1 for motor protection circuit breakers
- CSA-C22.2 No.60947-4-1 for motor protection circuit breakers

## Device Overview

### Device Description

TeSys GV5 / GV6 devices are equipped with direct rotary handles as standard.

The device operating controls, operation indicators, settings, and locking mechanisms for the direct rotary handle are located on the front of the device.

There are two models of rotary handle:

- Black handle for standard applications
- Red handle on yellow bezel for machine control applications

TeSys GV5 device

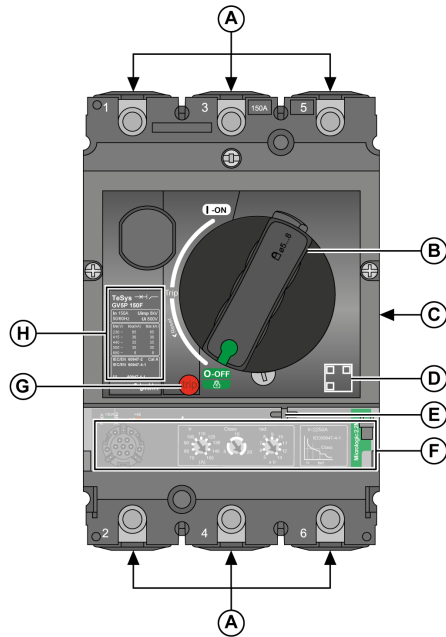

TeSys GV6 device

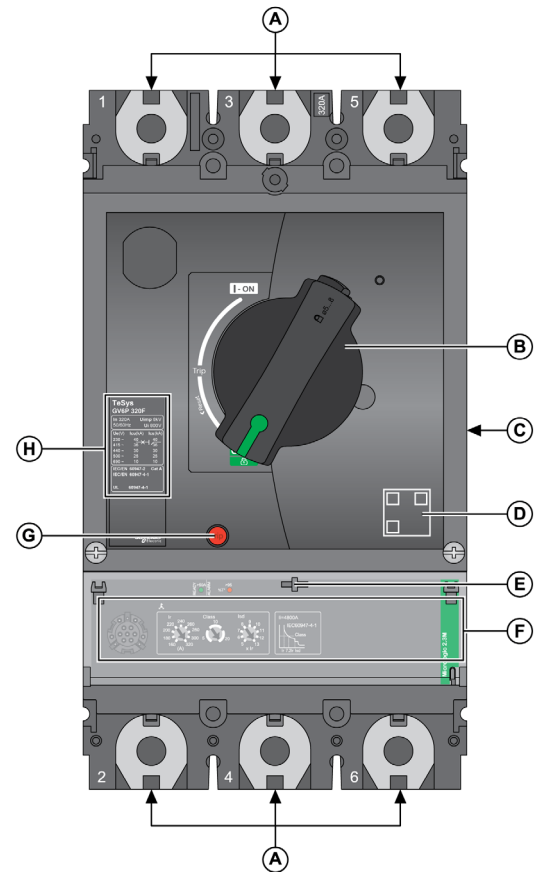

- A** Power connection  
**B** Direct rotary handle  
**C** Device and accessory data labels  
**D** QR code

- E** Seal for trip unit  
**F** Trip unit  
**G** Push-to-trip button  
**H** Rating plate

### QR code

Scan the QR code to get additional information about the device from the Schneider Electric website. To scan the QR code, use a smartphone that is equipped with a camera and installed with a QR code reader.

### Devices with Extended Rotary Handle

For devices with an extended rotary handle:

- The device operating controls are located on the front cover.
- The operation indicators and settings are accessible when the door is open.
- The locking mechanisms are located on the front cover (door closed) (see page 27).

There are two models of extended rotary handle:

- Black handle for standard applications
- Red handle on yellow bezel for machine control applications

Cabinet door open

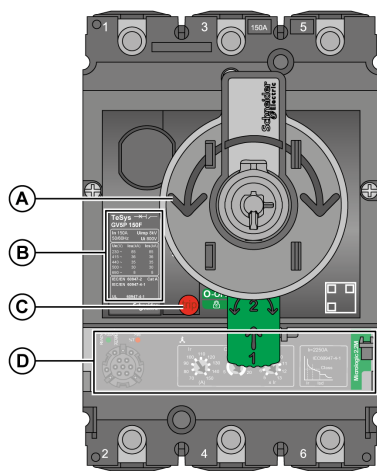

Cabinet door closed

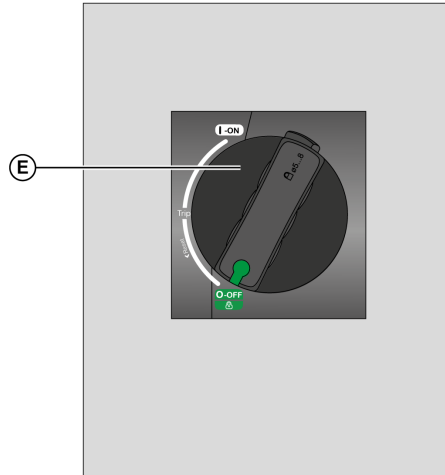

- A Open door shaft operator
- B Rating plate
- C Push-to-trip button
- D Trip unit
- E Extended rotary handle

### Rating Plate

The rating plate on the front of the device identifies the device and its characteristics. The rating plate depends on the breaking performances.

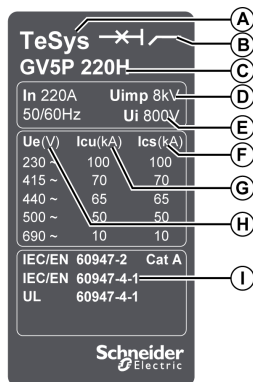

- A Range name
- B Type of device
- C Commercial reference
- D Uimp: rated impulse withstand voltage
- E Ui: rated insulation voltage
- F Ics: service breaking capacity
- G Icu: ultimate breaking capacity
- H Ue: rated operational voltage
- I Standards

## TeSys GV5 Accessories

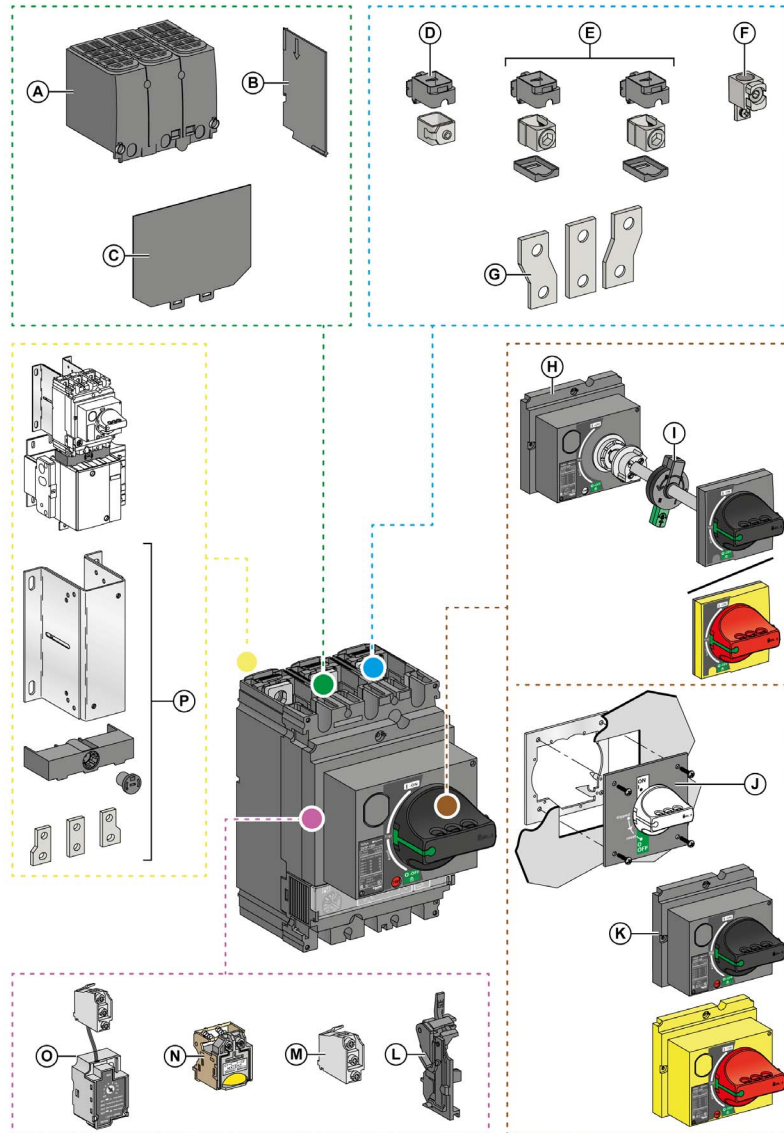

Legend	Accessory	Instruction sheet reference
A	Terminal shield	<a href="#">MFR49208</a>
B	Interphase barrier	<a href="#">MFR49208</a>
C	Insulating screen (45 mm / 1.8 in)	<a href="#">GHD16344AA</a>
D	Steel connector (1.5–95 mm <sup>2</sup> / 16-4/0 AWG)	<a href="#">MFR49208</a>
E	Aluminum connectors for one conductor (25-185 mm <sup>2</sup> / 4 AWG-350 kcmil)	<a href="#">MFR49208</a>
F	Aluminum connector for one conductor (120-240 mm <sup>2</sup> / 250-450 kcmil)	<a href="#">QGH14246</a>
G	Spreaders (35–45 mm / 1.4-1.8 in)	<a href="#">MFR49208</a>
H	Extended rotary handle	<a href="#">GHD16292AA</a>
I	Open door shaft operator	<a href="#">EAV78496</a>
J	MCC conversion accessory	<a href="#">GHD16295AA</a>
K	Spare direct rotary handle	<a href="#">MFR55037</a>
L	OF, SD, or SDE indication contacts	<a href="#">MFR55023</a>
M	SDE adapter	<a href="#">GHD16303AA</a>
N	AU (UVR) or AS (SHT) voltage releases	<a href="#">MFR55033</a>
O	SDTAM thermal fault module	<a href="#">GHD16274AA</a>
P	Combination kit for contactor	<a href="#">1378738</a>

TeSys GV6 Accessories

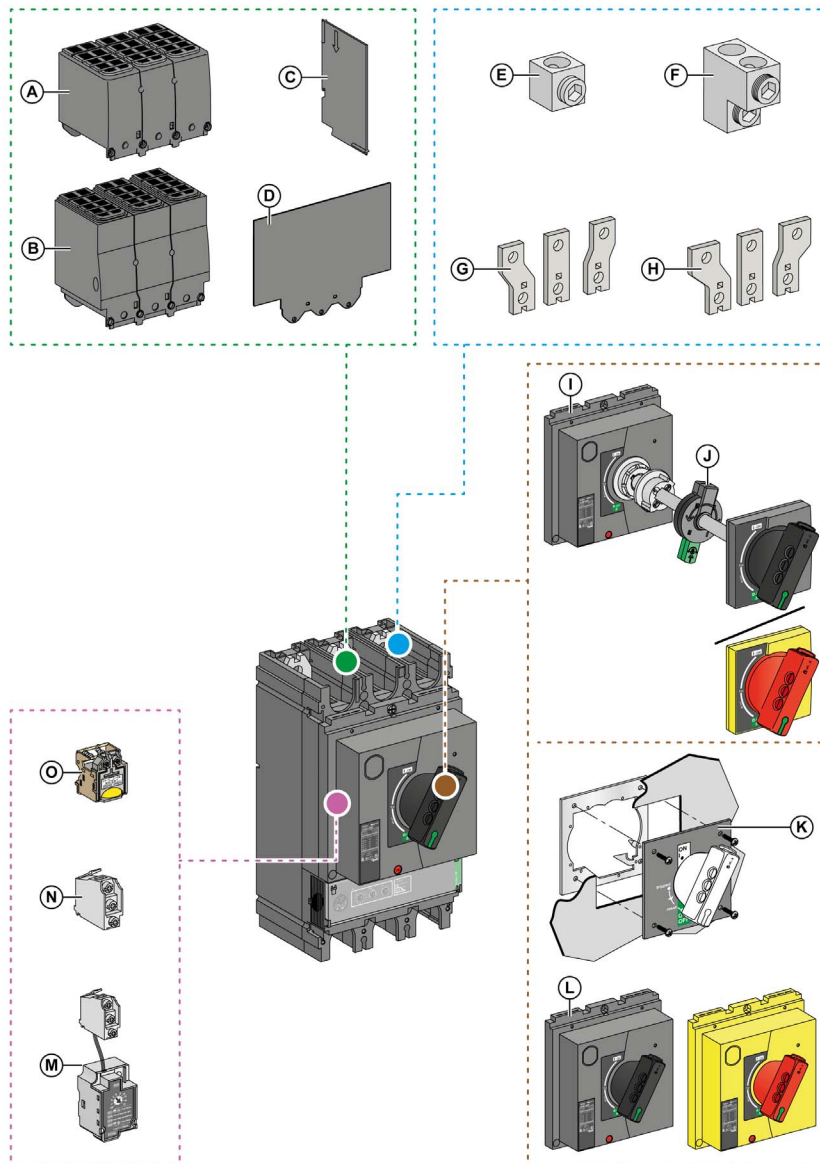

Legend	Accessory	Instruction sheet reference
A	Terminal shield (45 mm / 1.77 in)	<a href="#">MFR49209</a>
B	Terminal shield (52.5 mm / 2.07 in)	<a href="#">MFR49209</a>
C	Interphase barrier	<a href="#">MFR49209</a>
D	Insulating screen (70 mm / 2.76 in)	<a href="#">GHD16344AA</a>
E	Aluminum connector for one conductor (35-300 mm <sup>2</sup> / 2 AWG-600 kcmil)	<a href="#">MFR49209</a>
F	Aluminum connector for two conductors (35-240 mm <sup>2</sup> / 2 AWG-500 kcmil)	<a href="#">MFR49209</a>
G	Spreader (52.5 mm / 2.07 in)	<a href="#">MFR49209</a>
H	Spreader (70 mm / 2.76 in)	<a href="#">MFR49209</a>
I	Extended rotary handle	<a href="#">GHD16320AA</a>
J	Open door shaft operator	<a href="#">EAV78496</a>
K	MCC conversion accessory	<a href="#">GHD16295AA</a>
L	Spare direct rotary handle	<a href="#">MFR55039</a>
M	SDTAM thermal fault module	<a href="#">GHD16274AA</a>
N	OF, SD, or SDE indication contacts	<a href="#">MFR55023</a>
O	AU (UVR) or AS (SHT) voltage releases	<a href="#">MFR55033</a>

## Sealing Accessories

Use sealing accessories to prevent device operations.

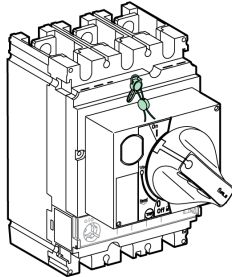
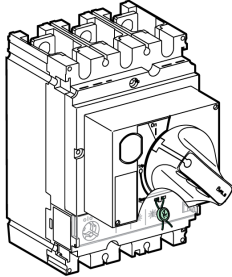
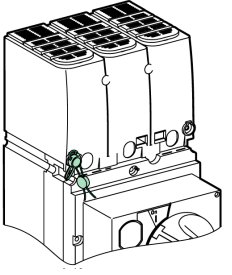
Seal type	Helps to prevent	Seal image
Seal for front cover mounting screw	<ul style="list-style-type: none"> <li>● Dismantling the front cover</li> <li>● Accessing the auxiliaries</li> <li>● Dismantling the trip unit</li> </ul>	
Seal for transparent protective cover of the trip unit	Altering trip unit settings	
Seal for mounting screw for terminal shields	Accessing the power connection (protection against direct contact)	

For more information about the installation of sealing accessories, consult the instruction sheet on the Schneider Electric website: [GHD16296AA](https://www.schneider-electric.com/resources/technical-documents/GHD16296AA).

## Environmental Conditions

### Ambient Temperature

The ambient temperature refers to the temperature of the air immediately surrounding the device.

- Operation temperature:
  - -25 to +70 °C (-13 to +158 °F): Normal operating temperature
  - -35 to -25 °C (-31 to -13 °F): Commissioning possible
- Storage temperature: -50 to +85 °C (-58 to +185 °F)

### Extreme Atmospheric Conditions

TeSys GV5 / GV6 devices are designed to operate in industrial atmospheres as defined in IEC/EN 60947-2 standard for the highest level of pollution (level 3).

They are tested for extreme storage conditions according to the following standards:

Standard	Title
IEC/EN 60068-2-2	Dry heat, severity level +85 °C (+185 °F)
IEC/EN 60068-2-1	Dry cold, severity level -50 °C (-58 °F)
IEC/EN 60068-2-30	Damp heat, cyclic <ul style="list-style-type: none"> <li>● temperature +55 °C (+131 °F)</li> <li>● relative humidity 95%</li> </ul>
IEC/EN 60068-2-52	Salt-mist test

It is recommended to install the device in a properly ventilated switchboard without excessive dust.

### Vibration

TeSys GV5 / GV6 devices are tested against vibration.

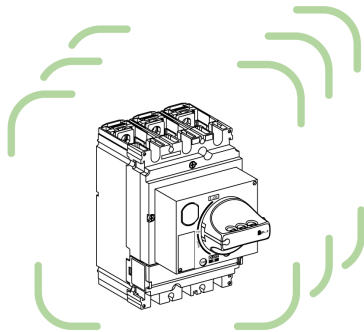

Conformity tests are carried out in accordance with IEC/EN 60068-2-6 standard at the levels of severity required by the merchant shipping regulatory body (DNV-GL):

- 2 Hz to 13.2 Hz with an amplitude of +/- 1 mm (+/- 0.04 in)
- 13.2 Hz to 100 Hz at a constant acceleration of 0.7 g



## Electromagnetic Disturbances

TeSys GV5 / GV6 devices are immune to electromagnetic disturbance.

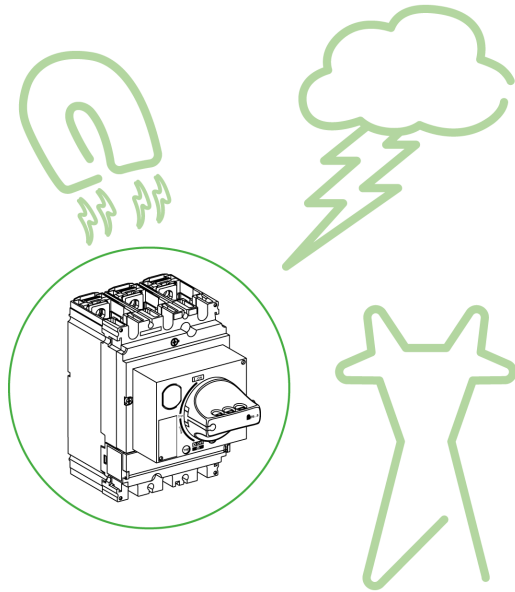

Overcurrent protection tests are carried out in accordance with the electromagnetic compatibility (EMC) standard (IEC/EN 60947-2 standard annexes F and J).

Check for compliance with EMC standard by testing for immunity to:

- Overvoltages produced by the operation of electromagnetic switchgear.
- Overvoltages produced by atmospheric disturbance that pass through the electrical network (for example, lightning).
- The use of apparatus emitting radio waves (such as radio transmitters, walkie-talkies, or radar).
- Electrostatic discharges produced by the operators themselves.

Conformity with EMC standard as described above helps to ensure that:

- The device operates correctly in a disturbed environment:
  - Without nuisance tripping.
  - In accordance with the trip time.
- There is no disturbance to any type of industrial or commercial environment.

**Altitude**

TeSys GV5 / GV6 devices are designed to operate within specification at altitudes of up to 2,000 m (6,600 ft).

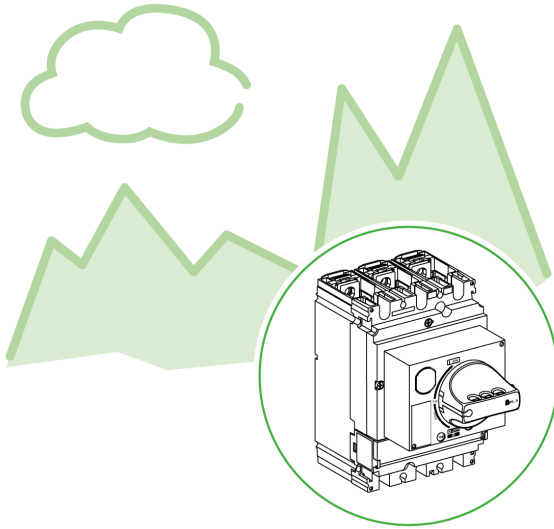

Above 2,000 m (6,600 ft) modifying the characteristics of the surrounding air (dielectric strength, cooling capacity) causes derating as follows:

Altitude (m/ft)	< 2,000 m (6,600 ft)	3,000 m (9,800 ft)	4,000 m (13,000 ft)	5,000 m (16,500 ft)
Maximum operating voltage (Vac)	690	690	635	560
Rated operational current at 40 °C (104 °F)	1.00	0.98	0.96	0.94

---

# Chapter 2

## Operating the Device

---

### What Is in This Chapter?

This chapter contains the following topics:

Topic	Page
Opening, Closing, and Resetting the Device	20
Testing a Device With Direct Rotary Handle	22
Locking a Device With Direct Rotary Handle	23
Testing a Device With Extended Rotary Handle	25
Locking a Device With Extended Rotary Handle	27
De-Energizing the Device	29

## Opening, Closing, and Resetting the Device

### Opening and Closing Locally

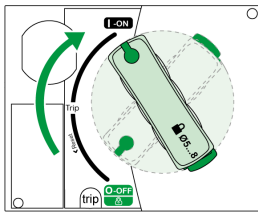

To close the device, turn the rotary handle clockwise from the **O (OFF)** position to the **I (ON)** position.

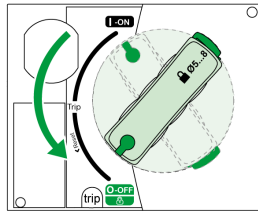

To open the device, turn the rotary handle counterclockwise from the **I (ON)** position to the **O (OFF)** position.

### Resetting After a Trip on Electrical Fault

#### **⚠ WARNING**

##### **HAZARD OF CLOSING ON ELECTRICAL FAULT**

Do not close the device again without first inspecting and, if necessary, repairing the downstream electrical equipment.

**Failure to follow these instructions can result in death, serious injury, or equipment damage.**

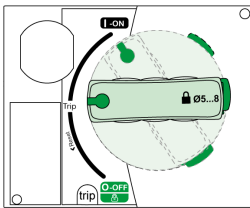

The device has tripped on electrical fault, the rotary handle has moved from the **I (ON)** position to the **Trip** position.

To reset after a trip on electrical fault:

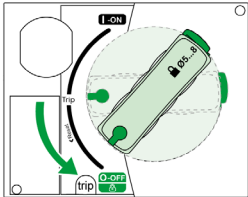
Step	Action	Position	
1	–	Isolate the feed ( <i>see page 29</i> ) before inspecting the downstream electrical equipment.	<b>Trip</b>
2	–	Look for the cause of the detected fault.	<b>Trip</b>
3	–	Inspect and, if necessary, repair the downstream equipment, using proper safety precautions.	<b>Trip</b>
4	–	Inspect the equipment in the event of a short-circuit trip.	<b>Trip</b>
5		Reset the device by turning the rotary handle counterclockwise from the <b>Trip</b> position to <b>O (OFF)</b> .	<b>O (OFF)</b>

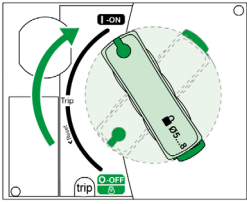
Step	Action	Position
6		I (ON)

**NOTE:** The fact that a device has tripped does not remedy the cause of the fault detected on the downstream electrical equipment.

## Testing a Device With Direct Rotary Handle

### Push-to-Trip Procedure

#### **⚠ CAUTION**

##### HAZARD OF NUISANCE TRIPPING

Device tests must only be done by qualified electrical personnel.

**Failure to follow these instructions can result in injury or equipment damage.**

When testing the trip mechanism, take precautions against:

- Disrupting operations
- Activating inappropriate alarms
- Triggering unwanted actions

For example, tripping the device with the push-to-trip button can lead to inappropriate fault indications or corrective actions (such as switching to an alternate power source).

Follow these steps to test the trip mechanism:

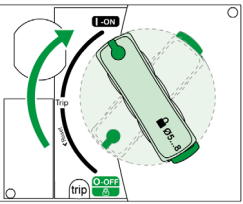
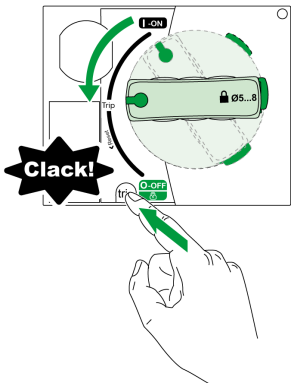
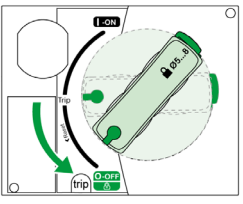
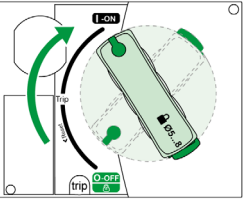
Step	Action	Position
1		I (ON)
2		Trip
3		O (OFF)
4		I (ON)

## Locking a Device With Direct Rotary Handle

### Handle Locking

Lock handle with up to three padlocks (not supplied).

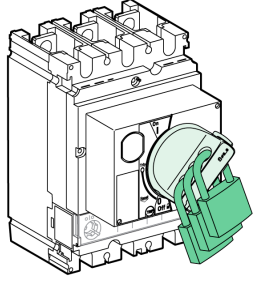
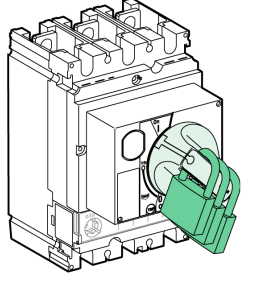
Handle locking		Padlocks
	<p>Padlocking (standard) only in the <b>O (OFF)</b> position.</p>	<p>Lock handle with up to three padlocks (not supplied) with shackle diameters of 5–8 mm (0.2–0.3 in).</p>
	<p>Padlocking in the two positions <b>I (ON)</b> and <b>O (OFF)</b> (optional). This locking option requires the removal, adaptation, and reinstallation of the rotary handle.</p>	<p>Lock handle with up to three padlocks (not supplied) with shackle diameters of 5–8 mm (0.2–0.3 in).</p>

**NOTE:** Locking the rotary handle in the **I (ON)** position does not disable the device protection functions. If there is an electrical fault, the device still trips. When unlocked, the handle moves to the **Trip** position. To return the device to service, follow the resetting instructions ([see page 20](#)).

### Door Locking (MCC Function)

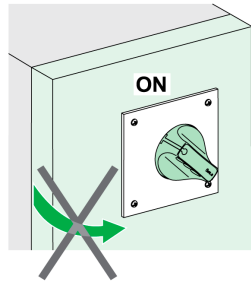

Locks the door in the closed position when the device is in the **I (ON)** position or in the **Trip** position.

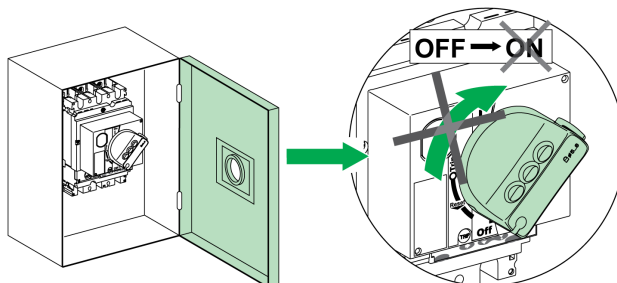

Helps to prevent the direct rotary handle from being moved to the **I (ON)** position when the door is open.

**⚡ ⚠ DANGER**

**HAZARD OF ELECTRIC SHOCK, EXPLOSION, OR ARC FLASH**

Only qualified persons are authorized to disable the door lock.

**Failure to follow these instructions will result in death or serious injury.**

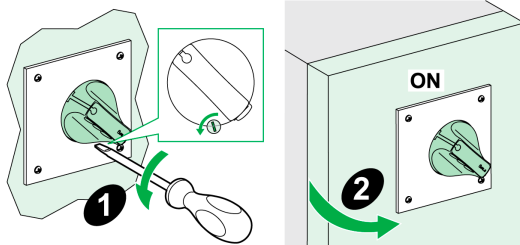

It is possible to temporarily disable this lock to open the door when the device is in the I (ON) position.

Disabling this lock requires modifying the rotary handle.

For more information, refer to [GHD16295AA](#), *TeSys GV5 / GV6 - Rotary Handle MCC Adaptor Plate - Instruction Sheet*.

If the lock has been disabled, the following direct rotary handle functions are inoperative:

- Door locking
- Preventing the device from being closed when the door is open



## Testing a Device With Extended Rotary Handle

### Push-to-Trip Procedure

#### **⚠ CAUTION**

##### HAZARD OF NUISANCE TRIPPING

Device tests must only be done by qualified electrical personnel.

**Failure to follow these instructions can result in injury or equipment damage.**

When testing the trip mechanism take precautions against:

- Disrupting operations
- Activating inappropriate alarms
- Triggering unwanted actions

For example, tripping the device with the push-to-trip button can lead to inappropriate fault indications or corrective actions (such as switching to an alternate power source).

There is no push-to-trip button on the door of a device with an extended rotary handle. To check the trip mechanism, the door must first be opened.

Follow these steps to test the trip mechanism:

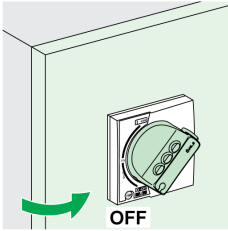
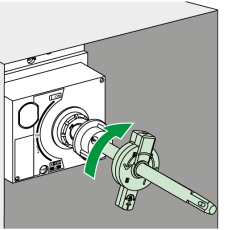
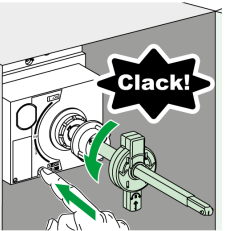
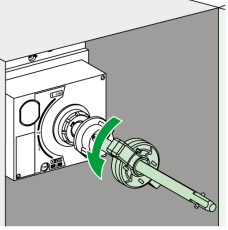
Step	Action	Position
1		Switch the device to the open <b>O (OFF)</b> position. Open the door. <b>O (OFF)</b>
2		Turn the device from the <b>O (OFF)</b> position to the <b>I (ON)</b> position, using one of the following tools: <ul style="list-style-type: none"> <li>• An open door shaft operator (LV426937).</li> <li>• A flat wrench, taking care not to damage the extension shaft or its surface treatment. The extension shaft is a hollow rectangular tube, 15 x 10 mm (0.59 x 0.39 in).</li> </ul> The device is ready for the test.
3		Press the push-to-trip button. The device trips. <b>Trip</b>
4		Use a special tool (refer to step 2) to turn the extension shaft counterclockwise and switch the device from the <b>Trip</b> position to the <b>O (OFF)</b> position. The device is in the open position. <b>O (OFF)</b>

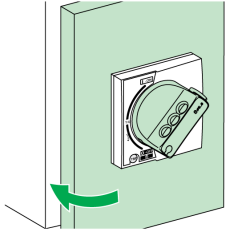
Step	Action	Position
5	 Close the door.	-

## Locking a Device With Extended Rotary Handle

### Handle Locking

The extended rotary handle offers several locking functions to:

- Prevent the rotary handle being operated.
- Prevent the door being opened.

Some locking functions can be disabled on different adaptations.

The handle can be locked with up to three padlocks (not supplied).

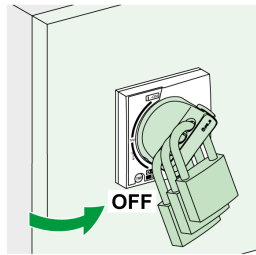
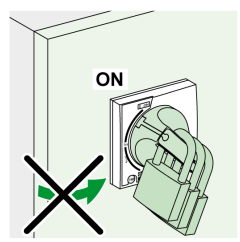
Handle locking		Padlocks
	<p>Padlocking (standard) in the <b>O (OFF)</b> position. Padlocking the rotary handle in the <b>O (OFF)</b> position does not prevent the door from opening.</p>	<p>Lock rotary handle with up to three padlocks (not supplied) with shackle diameters of 5–8 mm (0.2–0.3 in).</p>
	<p>Padlocking (after modification to the rotary handle during installation) in the two positions <b>I (ON)</b> and <b>O (OFF)</b>. There is a choice of two options when locking the rotary handle in the <b>I (ON)</b> position:</p> <ul style="list-style-type: none"> <li>• Standard with the door opening locked.</li> <li>• As an option, door is not interlocked, and locking the rotary handle does not stop the door from opening.</li> </ul>	<p>Lock rotary handle with up to three padlocks (not supplied) with shackle diameters of 5–8 mm (0.2–0.3 in).</p>

**NOTE:** Locking the rotary handle in the **I (ON)** position does not disable the device protection functions. If there is an electrical fault, the device still trips. When unlocked, the rotary handle moves to the **Trip** position. To return the device to service, follow the resetting instructions ([see page 20](#)).

### Door Locking (MCC Function)

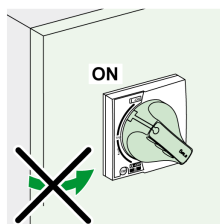

The extended rotary handle locks the door in the **I (ON)** position as standard.

## DANGER

### HAZARD OF ELECTRIC SHOCK, EXPLOSION, OR ARC FLASH

Only qualified persons are authorized to disable the door lock.

**Failure to follow these instructions will result in death or serious injury.**

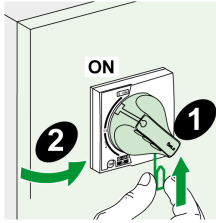

It is possible to temporarily disable this lock to open the door when the device is in the I (ON) position.

Disabling this lock requires modifying the rotary handle.

For more information, refer to:

- [GHD16292AA](#), *TeSys GV5 - Extended Rotary Handle - Instruction Sheet*.
- [GHD16320AA](#), *TeSys GV6 - Extended Rotary Handle - Instruction Sheet*.

**Example:** An application includes a device for a switchboard incoming supply and several device protecting motors with extended rotary handles installed behind the same door. Locking the door with the rotary handle of the incoming supply device simplifies maintenance work on the switchboard.

### Sealing Accessories

The sealing accessories for devices with extended rotary handles are identical to those for devices with direct rotary handles ([see page 23](#)).

## De-Energizing the Device

### Isolation Capacity

TeSys GV5 / GV6 devices offer positive contact indication and are suitable for isolation in accordance with IEC/EN 60947-1 and 2 standards. The O (OFF) position of the actuator is sufficient to isolate the device concerned.

The following marking on the rating plate label indicates that the device is capable of isolation:



To confirm this capability, IEC/EN 60947-1 and 2 standards require specific shock withstand tests.

TeSys GV5 / GV6 devices can be locked in the O (OFF) position to allow work to be carried out with the power off in accordance with installation rules. The device can only be locked in the open position if the device is in the O (OFF) position.

**NOTE:** Locking a TeSys GV5 / GV6 device in the open position is sufficient to isolate the device.

### Maintenance and Servicing Work on Installation

 <b>DANGER</b>
<b>HAZARD OF ELECTRIC SHOCK, EXPLOSION, OR ARC FLASH</b>
<ul style="list-style-type: none"> <li>• Apply appropriate personal protective equipment (PPE) and follow safe electrical work practices. See NFPA 70E or CSA Z462 or local equivalent.</li> <li>• This equipment must only be installed and serviced by qualified electrical personnel.</li> <li>• Turn off all power supplying this equipment before working on or inside equipment.</li> <li>• Always use a properly rated voltage sensing device to confirm that power is off.</li> <li>• Replace all devices, doors, and covers before turning on power to this equipment.</li> <li>• Repair the installation immediately if an insulation fault occurs during operation.</li> </ul>
<b>Failure to follow these instructions will result in death or serious injury.</b>

Turn off all power supplying the equipment before working on or inside equipment. For a partial powering down of the installation, the installation and safety rules require clearly labeling and isolating the feed being worked on.

### Maintenance Work Following a Trip on Electrical Fault

 <b>WARNING</b>
<b>HAZARD OF CLOSING ON ELECTRICAL FAULT</b>
Do not close the device again without first inspecting and, if necessary, repairing the downstream electrical equipment.
<b>Failure to follow these instructions can result in death, serious injury, or equipment damage.</b>

The following table describes the procedure to be followed after a trip on electrical fault:

Step	Action
1	Isolate the feed before inspecting the downstream electrical equipment.
2	Look for the cause of the detected fault.
3	Inspect and, if necessary, repair the downstream equipment.
4	Inspect the equipment in the event of a short-circuit trip.
5	Close the device again.

**NOTE:** The fact that a protection has tripped does not remedy the cause of the fault detected on the downstream electrical equipment.

### Checking the Settings

Checking settings does not require any particular precautions. The checks must be carried out by a qualified person.

## Testing the Device

 <b>CAUTION</b>
--

<b>HAZARD OF NUISANCE TRIPPING</b>
------------------------------------

Protection tests must be done by qualified electrical personnel.
--

<b>Failure to follow these instructions can result in injury or equipment damage.</b>
---

When testing device trip mechanisms, precautions must be taken:

- To avoid disrupting operations.
- To avoid inappropriate actions or tripping of alarms.

For example, tripping the device with the push-to-trip button can lead to inappropriate fault indications or corrective actions (such as switching to a replacement power source).

## Setting the Trip Unit

 <b>WARNING</b>
--

<b>HAZARD OF NUISANCE TRIPPING OR FAILURE TO TRIP</b>
---

Protection setting adjustments must be done by qualified electrical personnel.
--

<b>Failure to follow these instructions can result in death, serious injury, or equipment damage.</b>
---

Modifying trip unit settings requires a thorough knowledge of the installation and safety rules.

---

# Chapter 3

## Protection Functions

---

### What Is in This Chapter?

This chapter contains the following topics:

Topic	Page
Protection for Motor-Feeders	32
Motor Operating States	34
Trip Unit Description	35
Overload or Thermal Protection (ANSI 49)	37
Short-Time Protection (ANSI 51)	40
Instantaneous Protection (ANSI 50)	41
Phase Unbalance Protection (ANSI 46)	42

## Protection for Motor-Feeders

### Introduction

TeSys GV5 / GV6 devices:

- Provide protection for direct-on-line motor-feeders and star-delta motor starters (direct-on-line starting is the most widely used type of motor-feeder).
- Integrate the basic protections (overload, short-circuit, and phase unbalance) for the motor-feeder.
- Allow protection and coordination of the motor-feeder components that comply with the requirements of IEC/EN 60947-2 and IEC/EN 60947-4-1 standards.
- Are used to create motor-feeders with two devices.

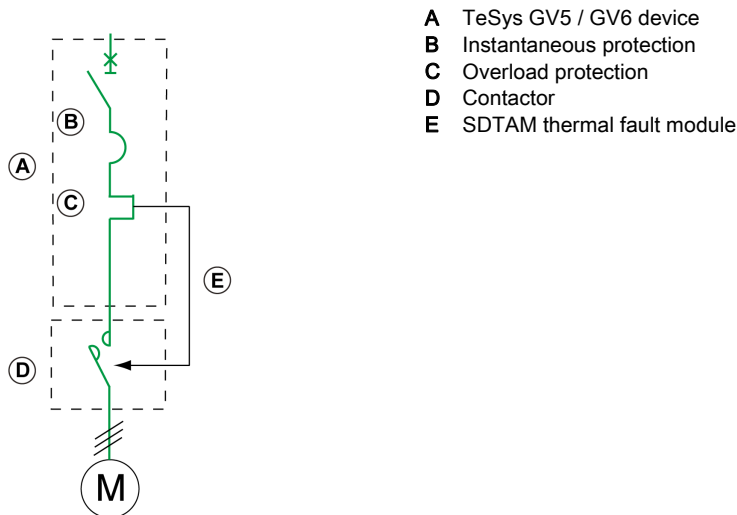

- A TeSys GV5 / GV6 device
- B Instantaneous protection
- C Overload protection
- D Contactor
- E SDTAM thermal fault module

### Characteristics Defined by IEC/EN 60947-4-1 Standard

A motor-feeder must satisfy the general rules of IEC/EN 60947-4-1 standard, in particular the rules concerning the protection of contactors and motor-feeders.

In the matter of protection, this standard defines:

- Coordination of motor-feeder protections
- Trip class setting value
- Insulation coordination



### Coordination According to IEC/EN 60947-4-1 Standard

Two types of coordination are allowed: type 1 coordination or type 2 coordination.

- In type 1 coordination, deterioration of the contactor and relay is accepted under the two following conditions:
  - The contactor or starter does not represent a danger to people or installations.
  - The starter can operate correctly when parts have been repaired or replaced.
- In type 2 coordination, some slight welding of the contactor or starter contacts is allowed if, following type 2 coordination tests:
  - They are easy to separate.
  - The control and protection switchgear functions then work without the need for repair.

To ensure type 2 coordination, IEC/EN 60947-4-1 standard lays down three  $I_d$  fault current tests intended to check that the equipment behaves correctly in overload and short-circuit conditions.

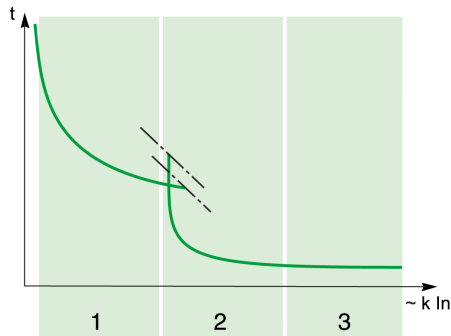

- 1 Overload zone  $I_d < 10 I_n$
- 2 Impedant short-circuit zone  $10 I_n < I_d < 50 I_n$
- 3 Short-circuit zone  $I_d > 50 I_n$

## Motor Operating States

### Introduction

TeSys GV5 / GV6 devices consider the application to be operating as soon as the 10% of  $I_r$  pickup is crossed in a positive direction by the motor current.

Two operating states are considered:

- Startup state
- Steady state

### Startup State

The application is considered to be in startup state according to the following criteria:

- Start: As soon as the 10% of  $I_r$  pickup is crossed in a positive direction by the motor current.
- End: As soon as the  $I_d$  pickup equals  $1.5 \times I_r$  and the  $t_d$  time delay equals 10 s (non-adjustable parameters).

Exceeding the 10 s time delay does not result in tripping.

**NOTE:** The trip unit filters the subtransient state (first current peak of approximately 20 ms on contactor closing). This current peak is not therefore taken into account when assessing whether the  $I_d$  pickup has been crossed.

### Steady State

The application is considered to be in steady state according to the following criteria:

- Start: As soon as startup ends.
- End: As soon as the 10% of  $I_r$  pickup is crossed in a negative direction by the motor current.

### Operating Diagram

The following diagrams show the two cases of transition between startup and steady state:

Operating states with current  $I < I_d$  before end of  $t_d$

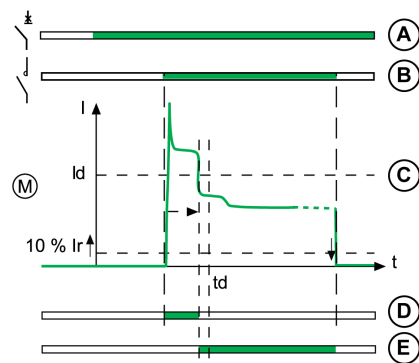

Operating states with current  $I > I_d$  at end of  $t_d$

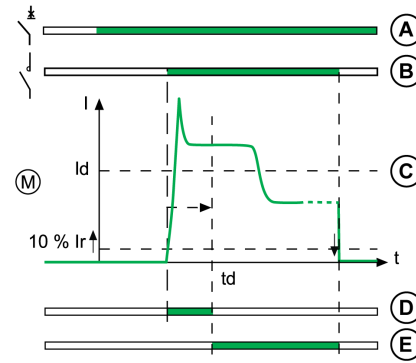

- A** TeSys GV5 / GV6 devices status (green: ON position)
- B** Contactor status (green: ON position)
- C** Current in the motor
- D** Operating state: startup state (green: active state)
- E** Operating state: steady state (green: active state)

## Trip Unit Description

### Introduction

The trip unit is suitable for protecting motor-feeders in standard applications. The thermal trip curves are calculated for self-ventilated motors. The adjustment dials and indications are located on the front face.

### Description

TeSys GV5 trip unit

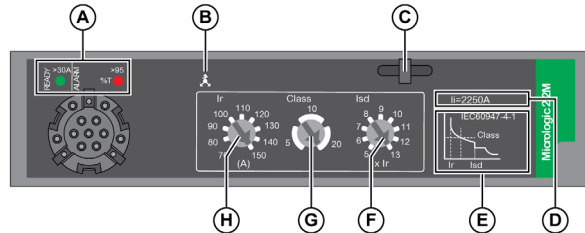

TeSys GV6 trip unit

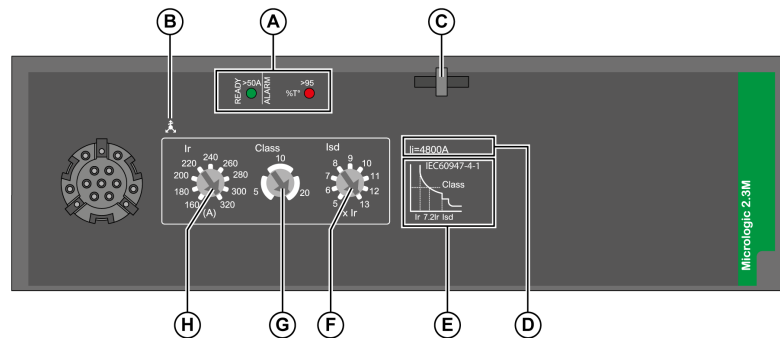

- A Indication LEDs
- B Phase-unbalance
- C Seal for setting cover
- D Instantaneous protection pickup (Ii)
- E Tripping curve
- F Adjustment dial for the short-time protection pickup (Isd)
- G Trip class setting
- H Adjustment dial for the overload or thermal protection pickup (Ir)

### Indication LEDs



Indication LEDs on the front of the trip unit indicate its operational state.

Indication LED	Description
Green <b>READY</b> LED	Blinks slowly when the electronic trip unit is ready to provide protection.
Red <b>ALARM</b> LED	Overload temperature alarm LED: Shows a steady light when the thermal image of the motor exceeds 95% of the Ir setting.

The indication LEDs function for device load currents above 30 A.

## Protection Functions

The following figure and table define the protection functions performed by the trip unit:

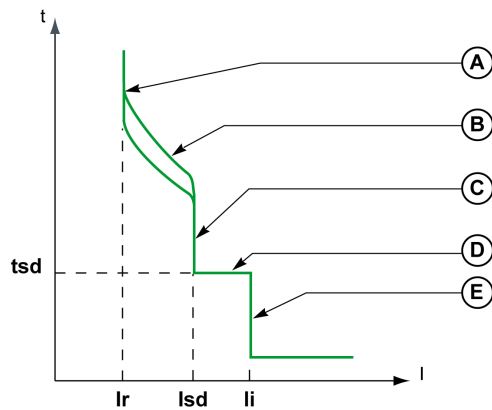

Item	Parameter	Description	Adjustable	Default setting	SDTAM activation
A	Ir	Overload or thermal protection pickup	Yes	0.4 x In	Yes
B	Class	Trip class	Yes	10	Yes
C	Isd	Short-time protection pickup	Yes	13 x Ir	No
D	tsd	Short-time protection time delay	No	0.1 s	No
E	Ii	Instantaneous protection pickup	No	17 x In	No
-	Iunbal	Phase-unbalance protection pickup	No	30%	Yes
-	tunbal	Phase-unbalance protection time delay during startup	No	0.7 s	Yes
		Phase-unbalance protection time delay in steady state	No	4 s	Yes

Each function is reviewed in detail on the following pages.

### Setting the Protection

Set the overload or thermal protection pickup (Ir), the short-time protection pickup (Isd), and trip class (Class) by using the dials on the device.

### Reflex Tripping

The system of reflex protection breaks very high fault currents by mechanically tripping the device with a piston actuated directly by the pressure produced in the device from a short-circuit. This piston operates the opening mechanism, resulting in ultra-fast device tripping (*see page 61*).

## Overload or Thermal Protection (ANSI 49)

### Introduction

Overload or thermal protection protects all types of motor applications against overload currents.

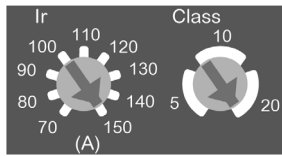

The long-time protection is set by two dials according to the starting characteristics of the application.

The pickup setting  $I_r$  for trip unit long-time protection is expressed in amperes:

- This value corresponds to the operating current used in the motor application.
- The maximum  $I_r$  setting corresponds to the trip unit rating  $I_n$ .

### Operating Principle

Overload or thermal protection is  $I^2t$  IDMT (Inverse Definite Minimum Time):

- It incorporates the motor thermal image function.
- It can be configured as the  $I_r$  pickup and as the trip class (Class).

Tripping curve:

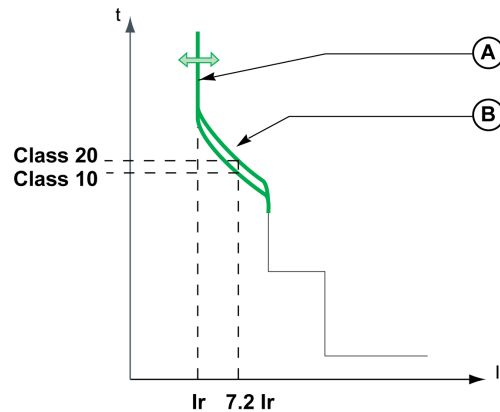

Item	Parameter	Description
A	$I_r$	Overload or thermal protection pickup
B	Class	Overload or thermal protection trip class (according to IEC/EN 60947-4-1 standard)

### $I_r$ Pickup Setting Value

The overload or thermal protection pickup ( $I_r$ ) is set by using a multi-position dial.

The default  $I_r$  pickup setting value is  $0.4 \times I_n$  (minimum dial value).

The overload or thermal protection tripping range is  $1.05\text{--}1.20 \times I_r$  according to IEC/EN 60947-4-1 standard.

The following table shows the preset values of the adjustment dial  $I_r$  in amperes for each current rating  $I_n$ :

Trip unit rating $I_n$ (A)	150 A	220 A	320 A	500 A
Pickup $I_r$ (A)	70	100	160	250
	80	120	180	280
	90	140	200	320
	100	155	220	350
	110	170	240	380
	120	185	260	400
	130	200	280	440
	140	210	300	470
	150	220	320	500

### Trip Class Setting Value

The trip class (Class) is set by using an adjustment dial:

- Class 5
- Class 10 (default value)
- Class 20

The trip class corresponds to the value of the tripping time for a current of  $7.2 \times I_r$  according to IEC/EN 60947-4-1 standard.

The following table shows the value of the tripping time depending on the current in the load for all three classes:

Current in the load	Tripping time (in seconds)		
	Class 5	Class 10	Class 20
$1.5 \times I_r$	96-120	192-240	320-400
$6 \times I_r$	5.2-6.5	10.8-13.5	20.8-26
$7.2 \times I_r$	4-5	8-10	16-20

The precision range is -20%, + 0%

### Motor Thermal Image

The model representing heat rise and cooling in a motor load is constructed according to the algorithm for calculating the thermal demand, taking account of the iron and copper losses.

The following figure represents the limit curves for the iron and copper components calculated for class 20:

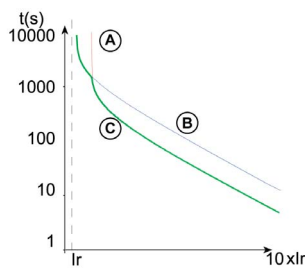

- A** Limit temperature curve for copper
- B** Limit temperature curve for iron
- C** Tripping curve (low envelope)

### Thermal Memory

The trip unit uses a thermal memory function to protect the motor from overheating in case of low amplitude repetitive faults.

Electronic protection without thermal memory function does not protect against repetitive faults because the duration of each overload above the pickup setting is too short to cause tripping. However, each overload causes a temperature rise in the installation. The cumulative effect of successive overloads can overheat the system. The thermal memory function remembers and integrates the thermal heating caused by each pickup setting overrun. The thermal memory function remembers the thermal heating values for 20 minutes before or after tripping.

**Example:** Comparison of the heat rise calculation without thermal image (diagram A) and with thermal image (diagram B):

Diagram A

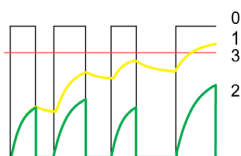
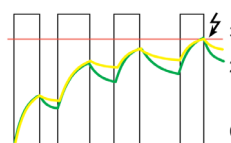

Diagram B



- 0** Load control (cyclical)
- 1** Motor temperature
- 2** Thermal level calculated without thermal image (diagram A), with thermal image (diagram B)
- 3** Overload or thermal protection level

With thermal image, the trip unit adds the thermal effect of successive current pulses. Tripping occurs based on the actual thermal state of the motor.

## Cooling Fan

The thermal image of the motor is calculated taking account of the fact that the motor is self-cooled (fan mounted on the shaft end).

## Short-Time Protection (ANSI 51)

### Introduction

Short-time protection protects all types of motor applications against short-circuit currents.

Short-time protection lets through motor starting currents but protects cables and motor starter devices and allows not to oversize them (useful for wide range settings devices).

### Operating Principle

Short-time protection is definite time. It can be configured as the  $I_{sd}$  pickup.

Tripping curve:

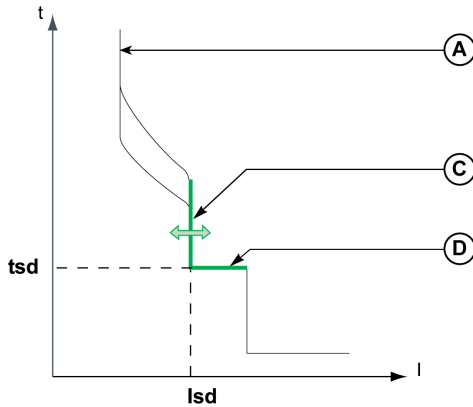

Item	Function	Description
A	$I_r$	Overload or thermal protection pickup
C	$I_{sd}$	Short-time protection pickup
D	$t_{sd}$	Short-time protection fixed time delay

### $I_{sd}$ Pickup Setting Value

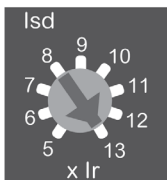

The short-time protection pickup  $I_{sd}$  is set by using a multi-position dial. The setting value is expressed in multiples of  $I_r$ .

Step	Action
1	Set the long-time protection first: the setting pickup is $I_r$ (A).
2	Turn the $I_{sd}$ adjustment dial to the value required. The setting range is 5 to 13 x $I_r$ in steps of $I_r$ .
3	$I_{sd}$ is set to $I_r$ (A) x $I_{sd}$ setting.

The precision range is +/-15%.

### $t_{sd}$ Time Delay Value

The time delay cannot be adjusted.

- The hold time is 20 ms.
- The maximum breaking time is 60 ms.



## Instantaneous Protection (ANSI 50)

### Introduction

Instantaneous protection protects all types of motor applications against very high intensity short-circuit currents.

### Operating Principle

Instantaneous protection is fixed: the pickup value is determined by the current rating  $I_n$ . Protection is instantaneous.

Tripping curve:

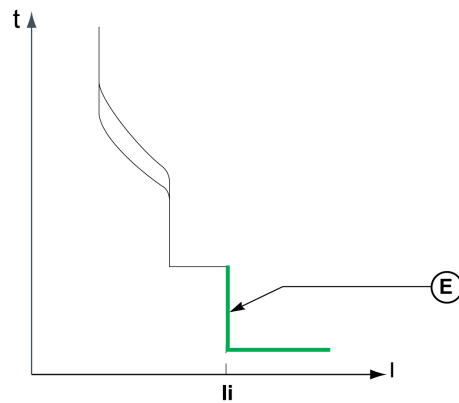

Item	Parameter	Description
E	$I_i$	Instantaneous protection pickup

### $I_i$ Pickup Value

The  $I_i$  pickup value is  $15 \times I_n$  (trip unit rating  $I_n$  corresponds to the maximum  $I_r$  setting).

The precision range is  $\pm 15\%$ .

The maximum breaking time is 30 ms.

## Phase Unbalance Protection (ANSI 46)

### Introduction



Unbalances of the motor phase currents lead to significant heat rise and braking torques that can cause premature deterioration of the motor. These effects are amplified during startup: protection must be almost immediate.

### Description

Phase unbalance protection:

- Calculates the current unbalance for each phase, compared to the average current, expressed as a percentage:

$$I_{avg} = \frac{(I_1 + I_2 + I_3)}{3}$$

$$I_k \text{ unbalance (\%)} = \frac{I_k - I_{avg}}{I_{avg}} \times 100 \text{ where } k = 1, 2, 3$$

- Compares the value of the maximum current unbalance with the lunbal protection pickup.

The following diagram shows a maximum positive unbalance on phase 2:

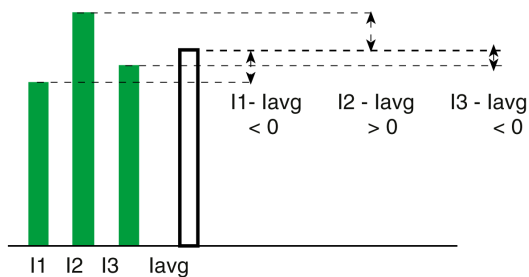

If the maximum current unbalance value is higher than the phase unbalance protection lunbal pickup, the tunbal time delay is actuated.

Phase unbalance protection cannot be deactivated.

Phase unbalance protection is activated during startup and in steady state.

## Operating Principle

- The phase unbalance (or phase loss) protection trips if the current unbalance exceeds the 30% fixed pickup  $I_{unbal}$  during a fixed  $t_{unbal}$  time delay. The  $t_{unbal}$  time delay differs according to the motor operating conditions:
  - Start-up phase:  $t_{unbal} = 0.7$  s
  - Steady state phase:  $t_{unbal} = 4$  s

Phase loss is an extreme case of phase unbalance and leads to tripping under the same conditions.

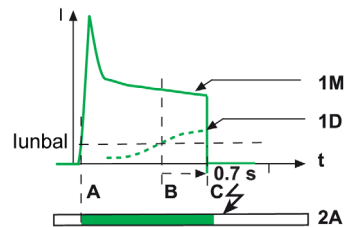

- 1M** Motor current  
**1D** Maximum unbalance of the motor phase currents  
**2A** Monitoring by phase unbalance protection during startup  
 White: Not active  
 Green: Active

During startup:

- A:** Activation of startup phase.
- B:** Activation of protection time delay as soon as the pickup is crossed.
- C:** Protection tripped at the end of the fixed time delay of 0.7 s.

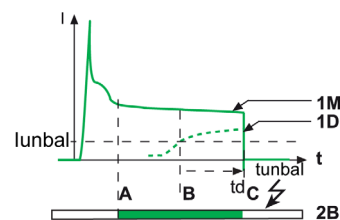

- 1M** Motor current  
**1D** Maximum unbalance of the motor phase currents  
**2B** Monitoring by phase unbalance protection in steady state  
 White: Not active  
 Green: Active

In steady state:

- A:** Activation of steady state phase.
- B:** Activation of protection time delay as soon as the pickup is crossed.
- C:** Protection tripped at the end of the fixed time delay of 4 s.

- The phase unbalance protection does not trip if the current unbalance falls below the  $I_{unbal}$  pickup before the end of the fixed  $t_{unbal}$  time delay.

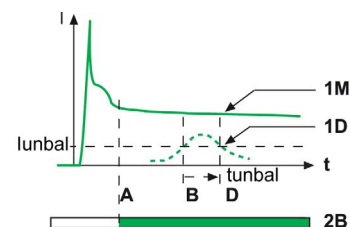

- 1M** Motor current  
**1D** Maximum unbalance of the motor phase currents  
**2B** Monitoring by phase unbalance protection in steady state  
 White: Not active  
 Green: Active

- A:** Activation of steady state phase.
- B:** Activation of protection time delay as soon as the pickup is crossed.
- D:** Time delay is reset.



---

# Chapter 4

## Electrical Auxiliary Devices

---

### What Is in This Chapter?

This chapter contains the following topics:

Topic	Page
Electrical Auxiliary Devices	46
Indication Contacts	49
Voltage Trip Releases	51
SDTAM Thermal Fault Module	52

## Electrical Auxiliary Devices

### Summary of Electrical Auxiliary Devices

The following table shows electrical auxiliary devices that can be added to devices. They can be installed on site. For more information, see the *TeSys Motor Control and Protection Components Catalog* (see page 7).

Electrical auxiliary device	Use
OF auxiliary contact	View the on/off status of the device remotely.
SD auxiliary contact	View the trip status of the device remotely.
SDE auxiliary contact	Indicate that the device has tripped on an electrical fault.
AU undervoltage trip release	Trip the device when the control voltage drops below a tripping threshold.
AS shunt trip	Send an electrical trip command remotely to trip the device.
SDTAM thermal fault module	Provide alarm and fault differentiation.

### Slots for Electrical Auxiliary Devices on TeSys GV5 Devices

The following table shows the possible slots for electrical auxiliary devices mounted in the case.

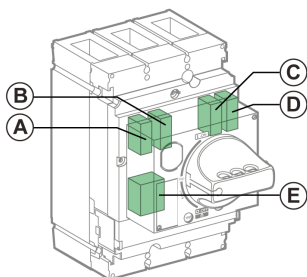

Electrical auxiliary device	Slot				
	A	B	C	D	E
OF1 auxiliary contact	✓	-	-	-	-
OF2 auxiliary contact	-	-	-	✓	-
SD auxiliary contact	-	✓	-	-	-
SDE auxiliary contact (with addition of the optional SDE adapter)	-	-	✓	-	-
AU undervoltage trip release	-	-	-	-	✓
AS shunt trip	-	-	-	-	✓
SDTAM thermal fault module	✓	-	-	-	✓

**NOTE:** It is not possible to install all the accessories at the same time in one device. For example, SDTAM thermal fault module uses the same slot as AU undervoltage trip release or AS shunt trip.

### Slots for Electrical Auxiliary Devices on TeSys GV6 Devices

The following table shows the possible slots for electrical auxiliary devices mounted in the case.

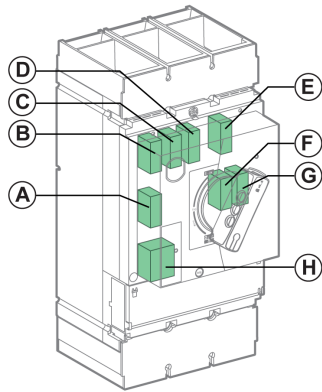

Electrical auxiliary device	Slot							
	A	B	C	D	E	F	G	H
OF1 auxiliary contact	-	✓	-	-	-	-	-	-
OF2 auxiliary contact	-	-	✓	-	-	-	-	-
OF3 auxiliary contact	-	-	-	✓	-	-	-	-
OF4 auxiliary contact	-	-	-	-	-	-	✓	-
SD auxiliary contact	-	-	-	-	✓	-	-	-
SDE auxiliary contact (with embedded SDE adapter)	-	-	-	-	-	✓	-	-
AU undervoltage trip release	-	-	-	-	-	-	-	✓
AS shunt trip	-	-	-	-	-	-	-	✓
SDTAM thermal fault module	✓	-	-	-	-	-	-	✓

**NOTE:** It is not possible to install all the accessories at the same time in one device. For example, SDTAM thermal fault module uses the same slot as AU undervoltage trip release or AS shunt trip.

### Operation of the Auxiliary Indication Contacts

The following table shows the position of the indication contacts (or outputs) relative to the position of the actuator and main contacts.

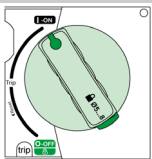
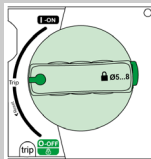
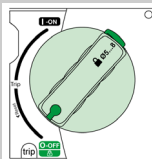
Position of the actuator and the main contacts								
								
	ON	Tripped by:						OFF
		AU/AS	PT <sup>(1)</sup>	Trip unit <sup>(2)</sup>				
				Ir	Isd	li	lunbal	
Name	Position of indication contacts							
OF	✓	-	-	-	-	-	-	-
SD	-	✓	✓	✓	✓	✓	✓	-
SDE	-	-	-	✓	✓	✓	✓	-
SDTAM - Output 1 (SDT thermal fault indication)	-	-	-	✓✓	-	-	✓✓	-
SDTAM - Output 2 (contactor control)	-	-	-	✓✓	-	-	✓✓	-
✓: Contact closed, ✓✓: Early-make output (400 ms)								
(1) PT: Push-to-trip (2) Ir: Overload or thermal protection Isd: Short-time protection li: Instantaneous protection lunbal: Phase-unbalance protection								



## Indication Contacts

### Introduction

Use indication contacts to view the status of the device remotely.

The indication contact provides either OF, SD, or SDE indication functions, depending on its location in the device.

Indication contacts are located under the front face of the device, in a compartment isolated from the power circuits.

### Description

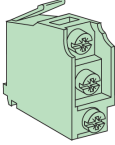
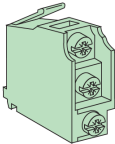
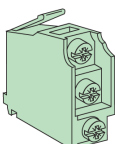
Name	Image	Definition
OF open/close indication contact		The OF contact indicates the position of the main contacts of the device (open or closed).
SD trip indication contact		The SD contact indicates that the device has tripped due to: <ul style="list-style-type: none"> <li>● Operation of the push-to-trip button</li> <li>● Operation of the AU undervoltage trip release or AS shunt trip</li> <li>● Overload or thermal protection</li> <li>● Short-time protection</li> <li>● Instantaneous protection</li> <li>● Phase-unbalance protection</li> </ul>
SDE electrical fault contact		The SDE contact indicates that the device has tripped on an electrical fault due to: <ul style="list-style-type: none"> <li>● Overload or thermal protection</li> <li>● Short-time protection</li> <li>● Instantaneous protection</li> <li>● Phase-unbalance protection</li> </ul>

### Characteristics

The contacts used for indication contacts are the common point changeover type.

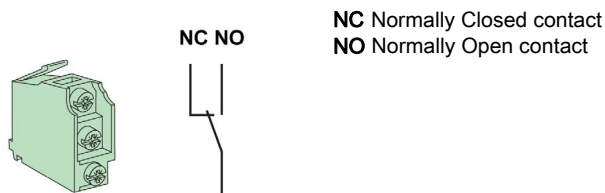

### Operation of the Indication Contacts

The following figures show the position of the indication contacts for each position of the handle and main contacts.

Name	Contact number	Position of the handle and contacts			
Handle position	–				
Device status	–	OFF	ON	Tripped on electrical fault	Tripped (by AU/AS or push-to-trip protection)
Main contact position	–	Open	Closed	Open	Open
OF auxiliary contact position	•1→2	Closed	Open	Closed	Closed
	•1→4	Open	Closed	Open	Open
SD auxiliary contact position	•1→2	Closed	Closed	Open	Open
	•1→4	Open	Open	Closed	Closed
SDE auxiliary contact position	•1→2	Open	Open	Closed	Open
	•1→4	Closed	Closed	Open	Closed

### Wiring Diagram

The diagram is shown with circuits de-energized, all devices open, connected, and charged, and relays in normal position.

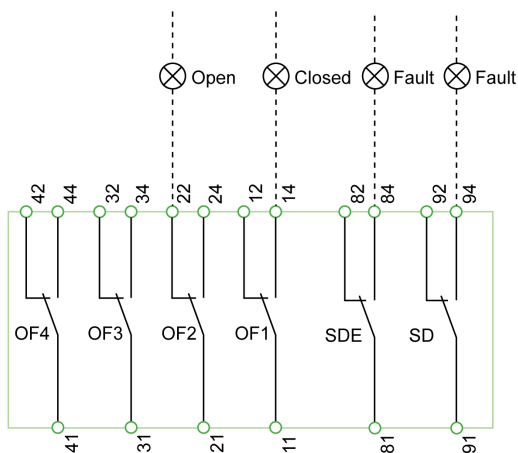

Indication contacts	Description
OF4/OF3/OF2/OF1	Device ON/OFF indication contacts
SDE	Electrical fault trip indication contact (short-circuit, overload, phase-unbalance)
SD	Trip indication contact

## Voltage Trip Releases

### Introduction

The following voltage trip release auxiliaries are operated remotely by an electrical trip command:

- AU undervoltage trip release
- AS shunt trip

**NOTE:** It is recommended to test the operation of a voltage trip release at regular intervals, such as every six months.

Voltage trip release auxiliaries are installed in the case under the front face of the device.

### Description

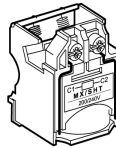
Name	Image	Description
AU undervoltage trip release		<p>AU undervoltage trip release:</p> <ul style="list-style-type: none"> <li>• Trips the device when the voltage is less than 0.35 times the rated voltage of the release. <ul style="list-style-type: none"> <li>○ If the voltage is between 0.35 and 0.7 times the rated voltage of the release, tripping can occur but is not certain to occur.</li> <li>○ If the voltage is above 0.7 times the rated voltage of the release, tripping cannot occur.</li> </ul> </li> <li>• Allows the device to be closed again when the voltage reaches 0.85 times the rated voltage of the release.</li> </ul> <p>Use this type of trip release for failsafe emergency stops.</p>
AS shunt trip		<p>AS shunt trip:</p> <ul style="list-style-type: none"> <li>• Trips the device when the voltage exceeds 0.7 times the rated voltage of the release.</li> <li>• Operates by impulse type control signals maintained for <math>\geq 20</math> ms.</li> </ul>

### Characteristics

The characteristics of voltage trip release auxiliaries comply with IEC/EN 60947-2 recommendations.

### Wiring diagram

The diagrams is shown with circuits de-energized, all devices open, connected, and charged, and relays in normal position.

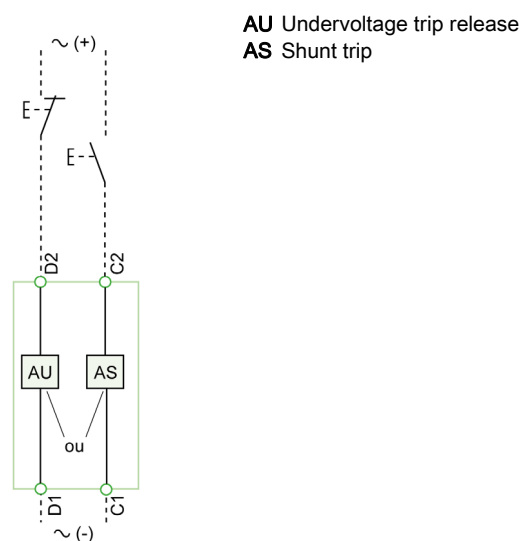

## SDTAM Thermal Fault Module

### Introduction

Use the SDTAM thermal fault module to manage tripping due to overload.

The SDTAM thermal fault module receives data from the trip unit through an optical link and makes available two outputs assigned to:

- Overload indication
- Motor contactor control

### Description

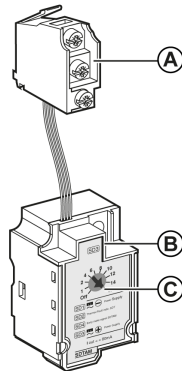

- A Output terminals
- B SDTAM thermal fault module
- C Operating mode adjustment dial

### Characteristics

The characteristics of the SDTAM thermal fault module outputs are:

- Voltage: 24–415 Vac/Vdc
- Current:
  - Active outputs: 80 mA maximum
  - Idle outputs: 0.25 mA

### Installation

The slots used to install the SDTAM thermal fault module depend on the device.

TeSys GV5

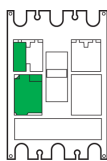

TeSys GV6

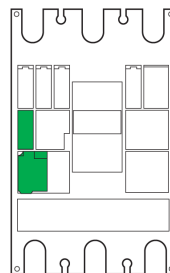

The SDTAM thermal fault module uses the same slot as:

- AU undervoltage trip release, AS shunt trip, or OF1 auxiliary contact in a TeSys GV5 device.
- AU undervoltage trip release or AS shunt trip in a TeSys GV6 device.

## Wiring diagram

Connect the SDTAM thermal fault module and the two outputs in strict accordance with the wiring diagram. The diagram is shown with circuits de-energized, all devices open, connected and charged and relays in normal position.

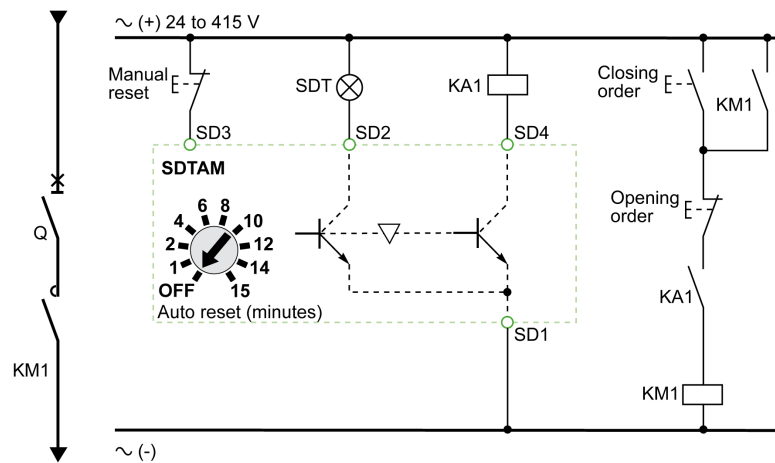

Item	Description
SD1, SD3	Thermal fault module input power supply
SD2	Overload fault signal output. This output maintains its state until reset.
SD4	Contactor control output
KM1	LC1D or LC1F contactor
KA1	CA2 or CAD-type control relays

## Output Assignment

Output 1 (SD2/OUT1): normally open, indicates thermal faults.

Output 2 (SD4/OUT2): normally closed, opens the contactor KM.

Outputs are activated 400 ms before the device trips in the case of:

- Overload or thermal protection
- Phase-unbalance protection

## Contactor Control

Contactor control by the output 2 signal (SD4/OUT2) optimizes continuity of service and provides the following additional benefits:

- Lower risk of motor deterioration.
- Activation of the output indicates that the application is not working normally. Abnormal operation is not the result of an anomaly or internal fault in the motor-feeder.
- The cause of this abnormal operation can be temporary (for example, a voltage drop causing an overly long starting time).

When the cause of the overload or unbalance has disappeared, the equipment can be powered up again.

**NOTE:** To control a contactor with a consumption exceeding 80 mA, it is necessary to provide a control relay.

## Operating Modes



The SDTAM thermal fault module incorporates an auto-reset delay setting dial.

To return the outputs to their initial state following activation:

- Manual (SDTAM dial in the OFF position) after canceling the module power supply.
- Automatic (SDTAM dial on one of the time delay adjustment settings) following a time delay (set from 1 to 15 minutes to allow for the motor cooling time).

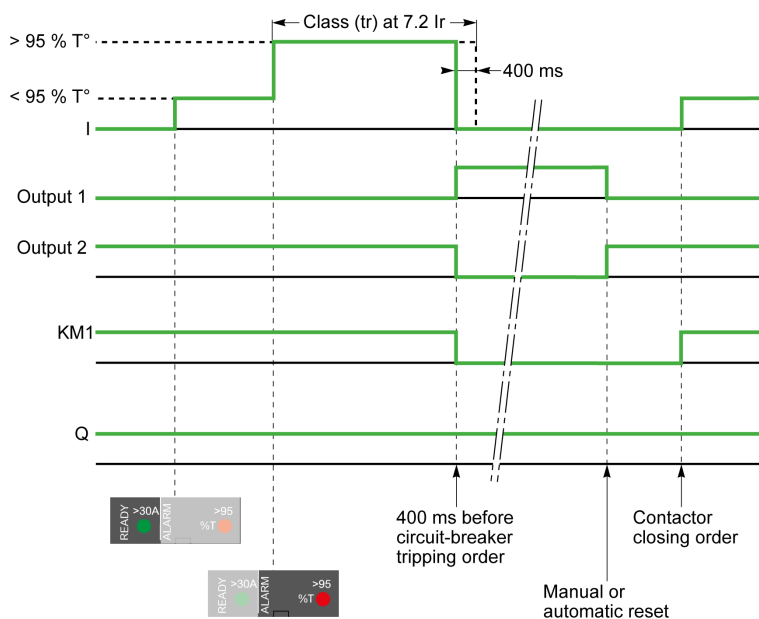

Item	Description
I	Motor current
Output 1	SDTAM overload fault signal output
Output 2	SDTAM contactor control output
KM1	Motor contactor
Q	TeSys GV5 / GV6 device

---

# Appendices

---



---



---

# Appendix A

## Additional Characteristics

---

### What Is in This Chapter?

This chapter contains the following topics:

Topic	Page
Motor-Feeder Protection	58
Reflex Tripping	61
Limitation Curves	62

## Motor-Feeder Protection

### TeSys GV5P150• and TeSys GV5P220• Tripping Curves

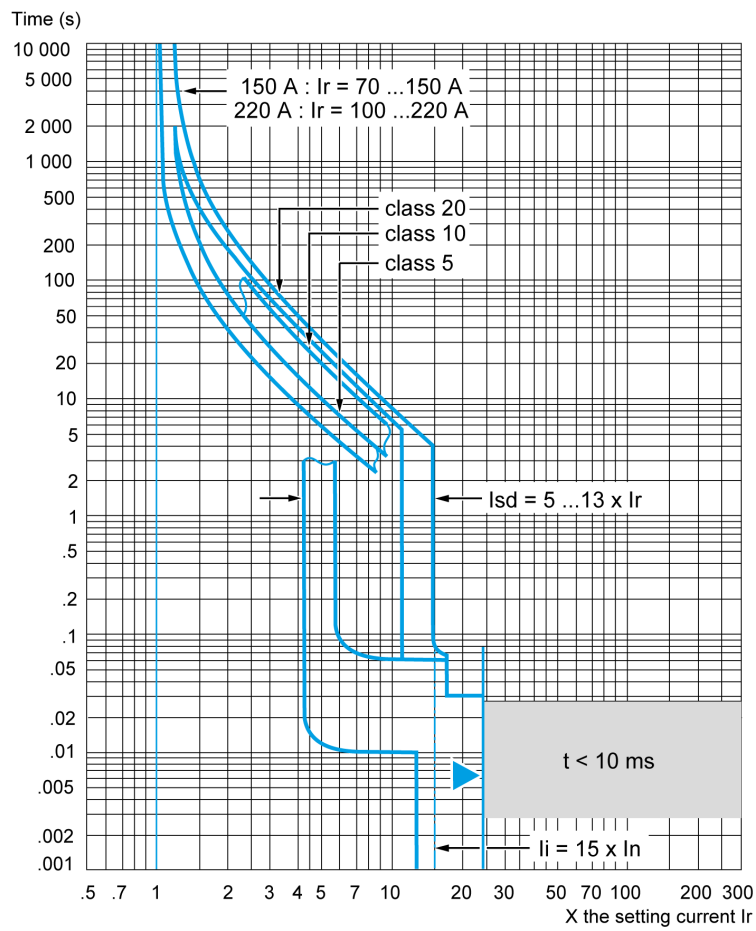

Reflex tripping

TeSys GV6P320• Tripping Curves

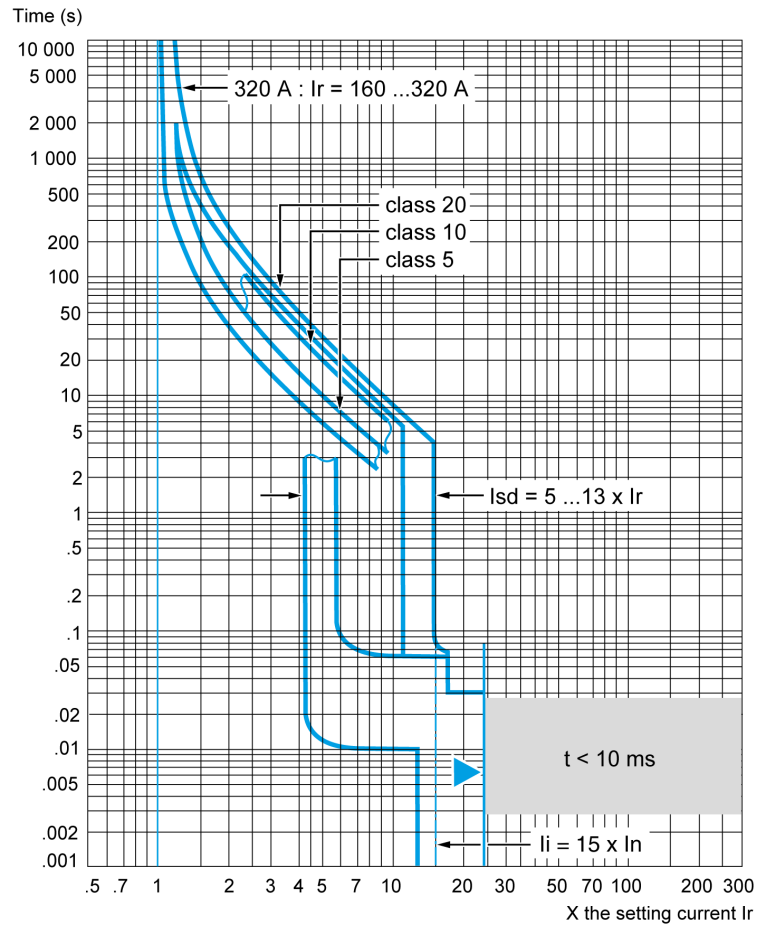

Reflex tripping

TeSys GV6P500• Tripping Curves

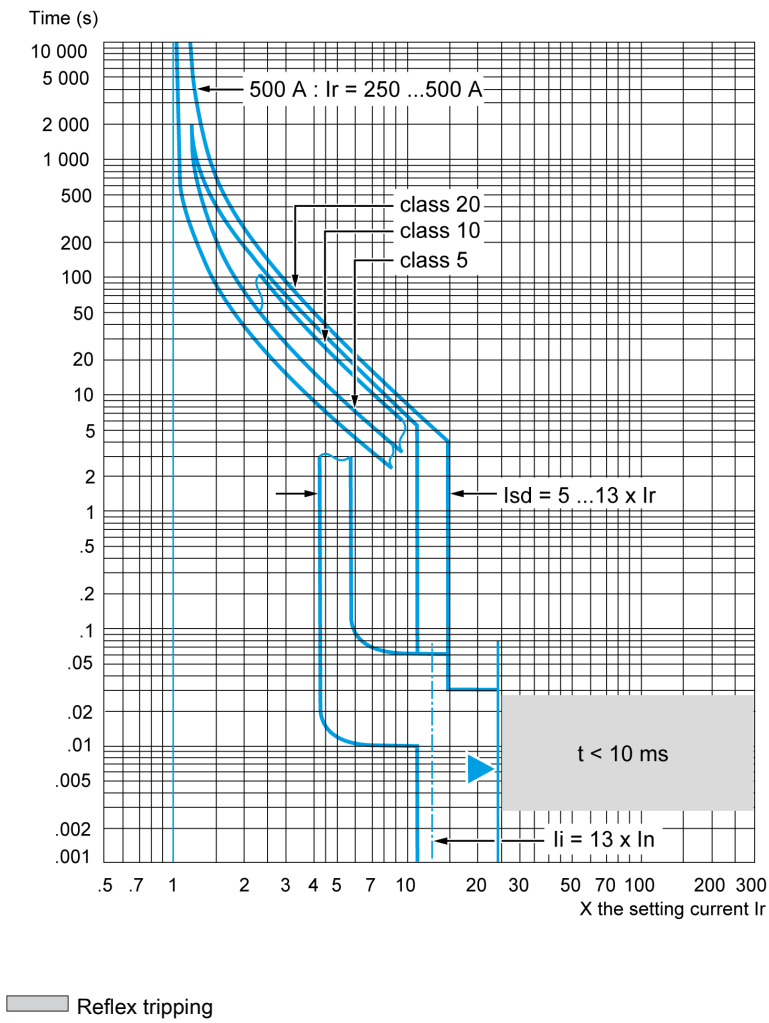

## Reflex Tripping

### Introduction

TeSys GV5 / GV6 devices incorporate the exclusive reflex-tripping system.

This system breaks very high fault currents.

The device is mechanically tripped via a "piston" actuated directly by the short-circuit.

For high short-circuits, this system provides a faster break, thereby ensuring discrimination.

Reflex-tripping curves are exclusively a function of the device rating.

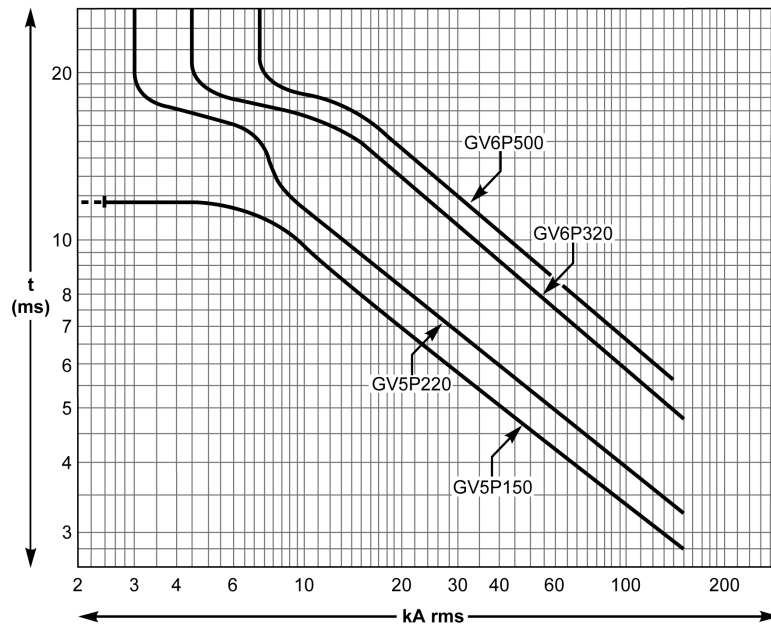

## Limitation Curves

### Introduction

The limiting capacity of a device is its aptitude to let through a current, during a short-circuit, that is less than the prospective short-circuit current.

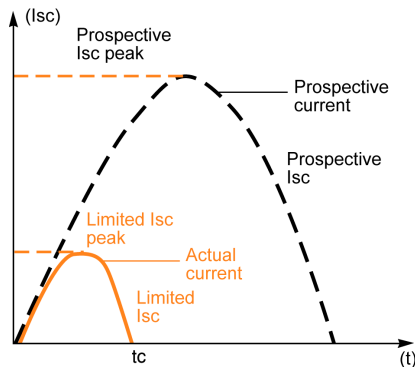

The exceptional limiting capacity of TeSys GV5 / GV6 devices is due to the rotating double-break technique (very rapid natural repulsion of contacts and the appearance of two arc voltages in-series with a very steep wave front).

### Ics = 100% Icu

The exceptional limiting capacity of TeSys GV5 / GV6 devices greatly reduces the forces created by faults in devices.

The result is a major increase in breaking performance.

In particular, the service breaking capacity Ics is equal to 100% of Icu.

The Icu value, defined by IEC/EN 60947-2 standard, is guaranteed by tests comprising the following steps:

- Break the circuit three times consecutively with a fault current equal to 100% of Icu
- Check that the device continues to function normally, that is:
  - It conducts the rated current without abnormal temperature rise.
  - Protection functions perform within the limits specified by the standard.
  - Suitability for isolation is not impaired.

### Longer Service Life of Electrical Installations

Current-limiting devices greatly reduce the negative effects of short-circuits on installations.

- Thermal effects: Reduced temperature rise in conductors, therefore longer service life for cables.
- Mechanical effects: Reduces electrodynamic forces, therefore less risk of electrical contacts, or busbar being deformed or broken.
- Electromagnetic effects: Reduction in disturbances for measuring devices located near electric circuits.

### Economy by Means of Cascading

Cascading is a technique directly derived from current limiting.

Devices with breaking capacities less than the prospective short-circuit current may be installed downstream of a limiting device.

The breaking capacity is reinforced by the limiting capacity of the upstream device.

It follows that substantial savings can be made on downstream equipment and enclosures.

### Current and Energy Limiting Curves

The limiting capacity of a device is expressed by two curves which are a function of the prospective short-circuit current (the current which would flow if no protection devices were installed):

- The actual peak current (limited current)
- Thermal stress ( $A^2s$ ), that is, the energy dissipated by the short-circuit in a condition with a resistance of  $1 \Omega$ .

### Maximum Permissible Cable Stresses

The table below indicates the maximum permissible thermal stresses for cables depending on their insulation, conductor (Cu or Al), and their cross-sectional area (CSA). CSA values are given in mm<sup>2</sup> and thermal stresses in A<sup>2</sup>s.

CSA	Conductor	1.5 mm <sup>2</sup> (16 AWG)	2.5 mm <sup>2</sup> (14 AWG)	4 mm <sup>2</sup> (12 AWG)	6 mm <sup>2</sup> (10 AWG)	10 mm <sup>2</sup> (8 AWG)
PVC	Cu	2.97x10 <sup>4</sup>	8.26x10 <sup>4</sup>	2.12x10 <sup>5</sup>	4.76x10 <sup>5</sup>	1.32x10 <sup>6</sup>
	Al	–	–	–	–	5.41x10 <sup>5</sup>
PRC	Cu	4.1x10 <sup>4</sup>	1.39x10 <sup>5</sup>	2.92x10 <sup>5</sup>	6.56x10 <sup>5</sup>	1.82x10 <sup>6</sup>
	Al	–	–	–	–	7.52x10 <sup>5</sup>

CSA	Conductor	16 mm <sup>2</sup> (6 AWG)	25 mm <sup>2</sup> (4 AWG)	35 mm <sup>2</sup> (2 AWG)	50 mm <sup>2</sup> (1 AWG)
PVC	Cu	3.4x10 <sup>6</sup>	8.26x10 <sup>6</sup>	1.62x10 <sup>7</sup>	3.31x10 <sup>7</sup>
	Al	1.39x10 <sup>6</sup>	3.38x10 <sup>6</sup>	6.64x10 <sup>6</sup>	1.35x10 <sup>7</sup>
PRC	Cu	4.69x10 <sup>6</sup>	1.39x10 <sup>7</sup>	2.23x10 <sup>7</sup>	4.56x10 <sup>7</sup>
	Al	1.93x10 <sup>6</sup>	4.7x10 <sup>6</sup>	9.23x10 <sup>6</sup>	1.88x10 <sup>7</sup>

### Current-limiting Curves

The following example shows a current-limiting curve of TeSys GV5 / GV6 devices on 400/440 Vac networks.

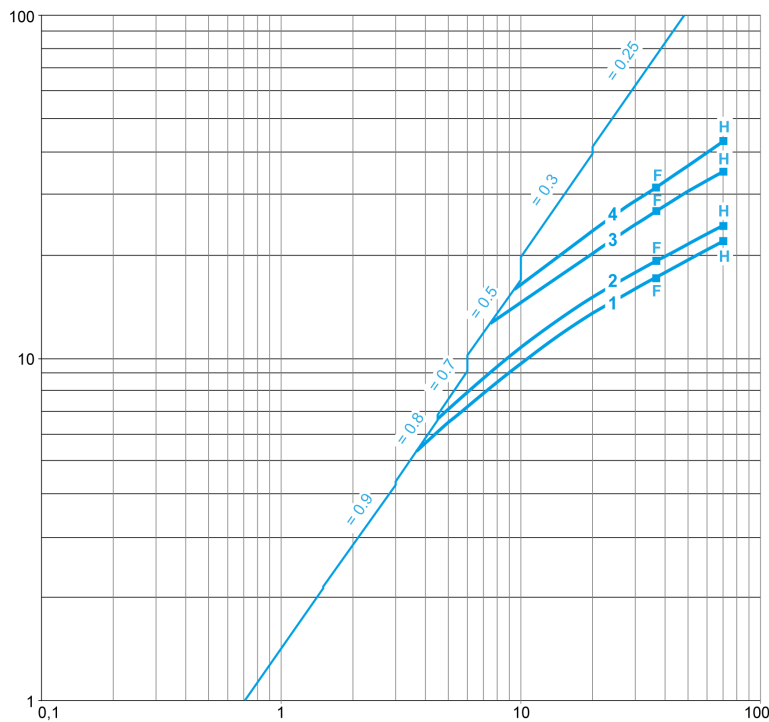

- 1 GV5P150F/H
- 2 GV5P220F/H
- 3 GV6P320F/H
- 4 GV6P500F/H

**Energy-limiting Curves**

The following example shows a energy-limiting curve of TeSys GV5 / GV6 devices on 400/440 Vac networks.

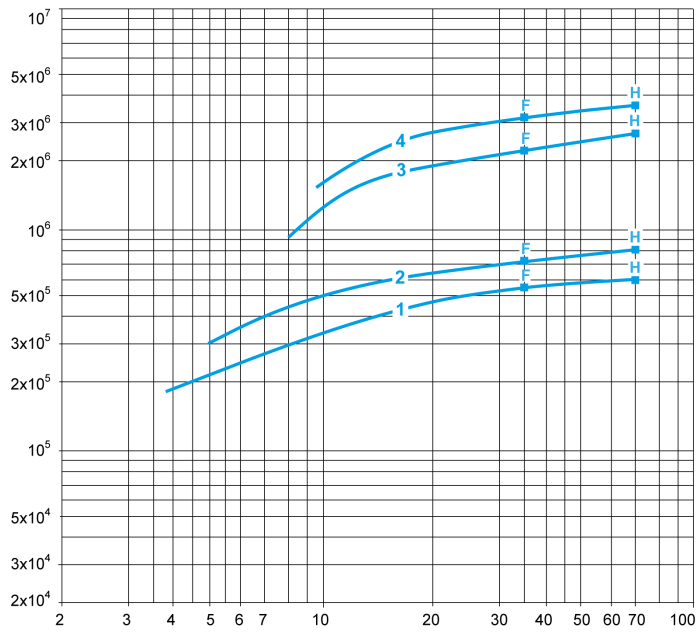

- 1 GV5P150F/H
- 2 GV5P220F/H
- 3 GV6P320F/H
- 4 GV6P500F/H





## A

### AS: Shunt trip

This type of release operates when supplied with current. The shunt (SHT) release provokes circuit breaker opening when it receives a pulse-type or maintained command.

### AU: Undervoltage release

This type of release (UVR) operates when the supply voltage drops below the set minimum.

### Auxiliary contact (IEC 60947-1)

Contact included in an auxiliary circuit and mechanically operated by the switching device.

## B

### Breaking capacity

Value of prospective current that a switching device is capable of breaking at a stated voltage under prescribed conditions of use and behavior. Reference is generally made to the ultimate breaking capacity (I<sub>cu</sub>) and the service breaking capacity (I<sub>cs</sub>).

## C

### Circuit breaker (IEC 60947-2)



Mechanical switching device, capable of making, carrying, and breaking currents under normal circuit conditions and making, carrying for a specified time and breaking currents under specified abnormal circuit conditions such as those of short-circuits. Circuit breakers are the device of choice for protection against overloads and short-circuits. Circuit breakers can, as is the case for TeSys GV, be suitable for isolation.

### Connection terminal

Flat copper surface, linked to the conducting parts of the device, and to which power connections are made using bars, connectors or lugs.

### Contactor (IEC 60947-1)



Mechanical switching device having only one position of rest, operated otherwise than by hand, capable of making, carrying and breaking currents under normal circuit conditions including operating overload conditions. A contactor is provided for frequent opening and closing of circuits under load or slight overload conditions. It must be combined and coordinated with a protective device against overloads and short-circuits, such as a circuit breaker.

### Contactor utilization categories (IEC 60947-4-1)

The standard defines four utilization categories, AC1, AC2, AC3 and AC4 depending on the load and the control functions provided by the contactor. The class depends on the current, voltage and power factor, as well as contactor withstand capacity in terms of frequency of operation and endurance.

## D

### Degree of protection - IP•• (IEC 60529)

Defines device protection against the penetration of solid objects and liquids, using two digits specified in IEC 60529 standard. Each digit corresponds to a level of protection, where 0 indicates no protection.

- First digit (0 to 6): Protection against penetration of solid foreign objects. 1 corresponds to protection against objects with a diameter less than 50 mm, 6 corresponds to total protection against dust.
- Second digit (0 to 8): Protection against penetration of liquids (water). 1 corresponds to protection against falling drops of water (condensation), 8 corresponds to continuous immersion.

The enclosure of TeSys GV motor circuit breakers provides a minimum of IP40 (protection against objects less than 1 mm).

**Direct rotary handle**

This is a control handle for the circuit breaker. It has the same three positions I (ON), O (OFF) and TRIP as the toggle control. It provides IP40 and IK07 protections. It maintains suitability for isolation and offers optional locking using a padlock.

**Durability**

The term “durability” is used in the standards instead of “endurance” to express the expectancy of the number of operating cycles which can be performed by the equipment before repair or replacement of parts. The term “endurance” is used for specifically defined operational performance.

**E****Electrical durability**

With respect to its resistance to electrical wear, equipment is characterized by the number of on-load operating cycles, corresponding to the service conditions given in the relevant product standard, which can be made without replacement.

**Electronic trip unit**

Trip unit that continuously measures the current flowing through each phase and the neutral if it exists. For MicroLogic, the measurements are provided by built-in current sensors linked to an analog-digital converter with a high sampling frequency. The measurement values are continuously compared by the ASIC to the protection settings. If a setting is overrun, a Mitop release trips the circuit breaker operating mechanism. This type of trip unit offers much better pick-up and delay setting accuracy than thermal-magnetic trip units. It also provides a wider range of protection functions.

**Extended rotary handle**

Rotary handle with an extended shaft to control devices installed at the rear of switchboards. It has the same characteristics as direct rotary handles. It offers multiple locking possibilities using a padlock or a door interlock.

**F****Failsafe remote tripping**

Remote tripping is carried out by an opening mechanism using an AU undervoltage release (UVR) in conjunction with an emergency off button. If power is lost, the protection device opens the circuit breaker.

**I****Ics: Service breaking capacity**

Expressed as a percentage of Icu, it provides an indication on the robustness of the device under severe conditions. It is confirmed by a test with one opening and one closing/opening at Ics, followed by a check that the device operates correctly at its rated current.

**Icu: Ultimate breaking capacity**

Expressed in kA, it indicates the maximum breaking capacity of the circuit breaker. It is confirmed by a test with one opening and one closing/opening at Icu, followed by a check that the circuit is properly isolated. This test ensures user safety.

**Ie: Rated operational current**

A rated operational current of an equipment is stated by the manufacturer and takes into account the rated operational voltage, the rated frequency, the rated duty, the utilization category and the type of protective enclosure, if appropriate.

**Ii: Instantaneous protection**

This protection supplements I<sub>sd</sub>. It provokes instantaneous opening of the device. The pick-up may be adjustable or fixed (built-in). This value is always lower than the contact-repulsion level.

**In: Rated current**

The rated current corresponds to the current that the device can carry continuously with the contacts closed and without abnormal temperature rise.

**Ir: Oervload or thermal protection**

Protection function where the adjustable I<sub>r</sub> pick-up determines a protection curve similar to the thermal-protection curve (inverse-time curve I<sup>2</sup>t). The curve is generally determined on the basis of the I<sub>r</sub> setting which corresponds to a theoretically infinite tripping time (asymptote) and of the point at 6 I<sub>r</sub> at which the tripping time depends on the rating.

**Isd: Short-time protection with fixed time delay**

This protection supplements thermal protection. Short-time protection, but with a fixed time delay. This function is available on MicroLogic 2M. The short-time pick-up Isd is adjustable from approximately 5 to 13 Ir.

**Iunbal: Phase-unbalance or phase-loss protection**

This protection function steps in if the current values and/or the unbalance in the three phases supplying the motor exceeds tolerances. Currents should be equal and displacement should be one third of a period. Phase-loss is a special case of phase-unbalance.

**M****Maximum breaking time**

Maximum time after which breaking is effective, which is when the contacts are separated and the current is completely interrupted.

**MCC rotary handle**

Handle used for motor control centers and providing IP43 and IK07 protections.

**Mechanical durability**

With respect to its resistance to mechanical wear, equipment is characterized by the number of no-load operating cycles which can be effected before it becomes necessary to service or replace any mechanical parts.

**P****Power loss / Pole resistance**

The flow of current through the circuit breaker poles produces Joule-effect losses caused by the resistance of the poles.

**R****Release (IEC 60947-1)**

A device which is mechanically connected to a mechanical switching device (for example a circuit breaker), which releases the holding means and permits the opening or the closing of the switching device. For circuit breakers, releases are often integrated in a trip unit.

**S****Safety clearances**

When installing a circuit breaker, minimum distances (safety clearances) must be maintained between the device and panels, bars and other protection systems installed nearby. These distances, which depend on the ultimate breaking capacity, are defined by tests carried out in accordance with IEC 60947-2 standard.

**SDTAM thermal fault module**

Relay module with two static outputs specifically for the motor-protection MicroLogic 2 M trip units. An output, linked to the contactor coil, opens the contactor when an overload or other motor fault occurs, thus avoiding opening of the circuit breaker. The other output stores the opening event in memory.

**Spreader**

Set of three flat conducting parts made of aluminum. They are screwed to the circuit breaker terminals to increase the pitch between poles.

**Starting current**

Start-up of a three-phase, asynchronous motor is characterized by:

- A high inrush current, approximately  $14 \times I_n$  for 10 to 15 ms
- A starting current, approximately  $7.2 \times I_n$  for 5 to 30 seconds
- Return to the rated current after the starting time

**Starting time**

Time after which the motor ceases to draw the starting current and falls back to the operating current  $I_r$  ( $\leq I_n$ ).

**Static output**

Output of a relay made up of a thyristor or triac electronic component. The low switching capability means that a power relay is required. This is the case for the SDTAM outputs.

**T****Thermal image of the rotor and stator**

The thermal image models the thermal behavior of a motor rotor and stator, taking into account temperature rise caused by overloads or successive starts, and the cooling constants. For each motor power rating, the algorithm takes into account a theoretical amount of iron and copper which modifies the cooling constants.

**Thermal protection**

Protection against over currents following an inverse time curve  $I^2t = \text{constant}$ , which defines the maximum permissible temperature rise for the motor. Tripping occurs after a time delay that decreases with increasing current.

**Trip class (IEC 60947-4-1)**

The trip class determines the trip curve of the thermal protection device for a motor feeder. The standard defines trip classes 5, 10, 20, and 30. These classes are the maximum durations, in seconds, for motor starting with a starting current of  $7.2 \times I_r$ , where  $I_r$  is the thermal setting indicated on the motor rating plate.

**U****Ue: Rated operational voltage**

A value of voltage which, combined with a rated operational current, determines the application of the equipment and to which the relevant tests and the utilisation categories are referred. For multiple equipment, it is generally stated as the voltage between phases. This is the maximum continuous voltage at which the equipment may be used.

**Ui: Rated insulation voltage**

The rated insulation voltage of an equipment is the value of voltage to which dielectric tests and creepage distances are referred. In no case shall the maximum value of the rated operational voltage exceed that of the rated insulation voltage.

**Uimp: Rated impulse withstand voltage**

The peak value of an impulse voltage of prescribed form and polarity which the equipment is capable of withstanding without failure under specified conditions of test and to which the values of the clearances are referred. The rated impulse withstand voltage of an equipment shall be equal to or higher than the values stated for the transient over voltages occurring in the circuit in which the equipment is fitted.









**DOCA0161EN-01**

**Schneider Electric Industries SAS**

35, rue Joseph Monier  
CS30323  
F - 92506 Rueil Malmaison Cedex

<http://www.se.com>

*As standards, specifications and designs change from time to time, please ask for confirmation of the information given in this publication.*

03/2020